

Alderamin MK3

Version:
v1.0.0

Date:
12.09.2024



Contents

1	Introduction	2
1.1	Overview	2
1.2	Features	2
1.3	Alderamin MK3 & Alderamin MK3-D CPU Options	2
1.4	Hardware Specification	3
1.5	Mechanical Specification	8
1.6	System I/O Placement	9
1.7	Recommended PoE Configuration and Environmental Spec Matrix	12
2	Regulatory Compliances	13
2.1	CE and UKCA Notice	13
2.2	Railway Application and Environmental Testing	13
3	DIP Switch settings and pin definition	15
3.1	Jumper and Internal Connector Overall Placement	15
3.2	DIP Switch Setting	16
3.3	Internal Connector Pin Definition	17
3.4	External Connector Pin Definition	22
3.5	Expansion Module COM/DIO	25
3.6	Expansion Module LAN	27
3.7	Expansion Module IGN	28
4	System Setup	29
4.1	2.5" SATA HDD/SSD Installation	29
4.2	2nd and 3rd 2.5" SATA HDD/SSD Installation	31
4.3	CPU/CPU Heatsink/DRAM Installation	33
4.4	RTC Battery Maintenance	36
4.5	External Fan (Optional) Installation Guide	37
5	BIOS Setup	39
5.1	Main Page	39
5.2	Advanced Page	41
5.3	Security Page	55
5.4	Boot Page	60

1 Introduction

This chapter provides the ALDERAMIN MK3 Embedded System product overview, including features, hardware, mechanical specifications, and I/O placement.

1.1 Overview

Welotec's ALDERAMIN MK3 embedded system is the next generation embedded system with Intel® Coffee Lake C246 workstation chipset which can support Xeon and Core-i LGA1151 socket type processor. The excellent performance, powerful processor, OCP/OVP power protection, and expandable design provide the solution for every complicated task and most types of application.

1.2 Features

ALDERAMIN MK3 Embedded System offers the following features:

- 8th & 9th Generation Intel® Xeon-E, Core™ i7 / i5 / i3 Processors
- Triple Display with HDMI, DisplayPort, and DVI-I Interface
- Fan-less chassis and Expandable module design
- Support COM/DIO/LAN/PoE via Expansion Modules
- Support Power Ignition for Vehicle Application via Xpansion Module
- 9-48V Wide Power Voltage
- -40 to 70 Celsius degrees Wide Temperature with 35W CPU -40 to 50 Celsius degrees Wide Temperature with 51-65W CPU -40 to 40 Celsius degrees Wide Temperature with 71-80W CPU

1.3 Alderamin MK3 & Alderamin MK3-D CPU Options

Processor Name	Cores	Threads	TDP
Intel® Xeon® E Processor			
Intel® Xeon® E-2176G Processor, 12M Cache, up to 4.70 GHz	6	12	80W
Intel® Xeon® E-2124G Processor, 8M Cache, up to 4.50 GHz	4	4	71W
Intel® Coffee Lake Refresh 9th Generation			
Intel® Core™ i7-9700TE Processor, 12M Cache, up to 3.80 GHz	8	8	35W
Intel® Core™ i5-9500E Processor, 9M Cache, up to 4.20 GHz	6	6	65W
Intel® Core™ i5-9500TE Processor, 9M Cache, up to 3.60 GHz	6	6	35W
Intel® Core™ i3-9100E Processor, 6M Cache, up to 3.70 GHz	4	4	65W
Intel® Core™ i3-9100TE Processor, 6M Cache, up to 3.20 GHz	4	4	35W

1.4 Hardware Specification

Sys-tem	
CPU	8th Gen Intel® Coffee Lake Xeon-E / Core-i LGA1151 Socket Processor TDP Max. 80W
Chipset	Intel® C246
Sys-tem Mem-orey	DDR4 2666MHz, 2 x 260-pin SO-DIMM, Max. 64GB (Xeon: ECC; Core-i: Non-ECC)
Graph-ics	Intel® HD Graphics
Dis-play In-ter-face	HDMI, DisplayPort, DVI-I
Stor-age Slot	3 x 2.5 HDD / SSD (1 w/ Removable HDD Bay; 2 w/ Internal HDD Bracket, 1st SATA cable as Default, 2nd SATA cable as Option) 2 x mSATA
Eth-er-net	Intel® I219-LM Giga LAN + I210-IT Giga LAN
Au-dio	Realtek® ALC662
I/O Chipset	Nuvoton NCT6116D
TPM	Nuvoton NPCT750AAAYX
Ex-pansion Slot	Storage: M.2 2242 / 2260 / 2280 M key (PCIe X4 / SATA) Storage/LTE/Wireless: 2 x Mini PCIe Full / Half size (USB / PCIe / SATA), w/ SIM Card Holder Wireless: M.2 2230 E key (PCIe / USB) a. PCIe 3.0 x16 (ALDERAMIN MK3) b. PCIe 3.0 x16 + PCIe 3.0 x1 (ALDERAMIN MK3-D Default) c. PCIe 3.0 x8 + PCIe 3.0 x8 (ALDERAMIN MK3-D Option)
Indi-ca-tor	Power LED, HDD LED, DIO LED, LAN1 & 2 ACT / SPEED
FRONT I/O	2 x USB 3.0 1 x HDMI 1.4 2 x SIM Card Slot w/ Cover 1 x 2.5" SATAIII HDD / SSD Bay
REAR I/O	4 x USB 3.1 Gen 2 (Gbps), 2 x USB 2.0, 2 x RJ-45 , 1 x DisplayPort 1.2, 1 x DVI-I, 1 x PS/2 2 x RS232 / 422 / 485 (Support Power 5V / 12V), 1 x Mic-in, 1 x Line-out 1 x 2-pin Terminal Block Remote Power on / off 1 x 2-pin Terminal Block Remote Power reset 1 x 4-pin Terminal Block External Fan Connector 1 x 3-pin Terminal Block Power Input 4 x SMA Antenna (Optional for WiFi/LTE function)
Watch-dog Timer	1~255 Steps by Software Program

Power Re-quire-ment	
Power Input	9~48V Wide Range DC Input w/ Terminal Block Connectivity *For DC source in directly, the maximum operating ambient temperature is 70°. For using with External AC adaptor model: EA13001N-240 (for 12.5A rating), the maximum ambient operating temperature is 40° if the system will be for using with external AC adaptor model: EA13001N-240.

Mechanical	
Thermal Design	a. ALDERAMIN MK3: Fanless b. ALDERAMIN MK3-D: Fanless or with 2 x 40m x 20cm Internal System Fan (External System Fan Kit as Option in Accessories)
Mounting	Wall mount
Dimension	a. ALDERAMIN MK3: 10.6" x 9.7" x 4.3" (268 mm x 246 mm x 108 mm) b. ALDERAMIN MK3-D: 10.6" x 9.7" x 5" (268 mm x 246 mm x 128 mm)
Material	Top cover: ALuminium Alloy, Bezel and chassis: Steel

En- vi- ron- men- tal	
Op- er- at- ing Tem- per- a- ture	a. ALDERAMIN MK3 & ALDERAMIN MK3-D Fanless Design: 35W TDP Processor: -40°C to 70°C 51~65W TDP Processor: -40°C to 50°C 71~80W TDP Processor: -40°C to 40°C(with 0.7m/s Air Flow and Wide Temperature Memory/Storage) b. ALDERAMIN MK3-D Fan Design, for max. 120W GFX Card thermal design, add Internal 40x20 System Fan x 2: 35W TDP Processor: -20°C to 50°C 51~65W TDP Processor: -20°C to 45°C 71~80W TDP Processor: -20°C to 40°C (with 0.7m/s Air Flow and Wide Temperature Memory/Storage) c. ALDERAMIN MK3-D Fan Design, for max. 120W GFX Card thermal design, add Internal 40x20 System Fan x 2 & External System Fan: 35W TDP Processor: -20°C to 55°C 51~65W TDP Processor: -20°C to 50°C 71~80W TDP Processor: -20°C to 45°C (with 0.7m/s Air Flow and Wide Temperature Memory/Storage) d. ALDERAMIN MK3-D Fan Design, for Nvidia 70W T4 and 75W P4 Card, add Internal 40x28 System Fan x 2: 35~80W TDP Processor: -20°C to 50°C (with 0.7m/s Air Flow and Wide Temperature Memory/Storage)
Op- er- at- ing Hu- mid- ity	10%~90% R/H (Non-condensing)
Vi- bra- tion Re- sis- tence	Operating, 5 Grms, 5-500 Hz, 3 Axes (w/ SSD, according to IEC60068-2-64; w/o GFX Card)
Shock Re- sis- tance	Shock Operating, 50 Grms, Half-sine 11 ms Duration (w/ SSD, according to IEC60068-2-27; w/o GFX Card)

OS	
OS Support	Windows® 10 64-bit, Linux (support by request)



*Notes^1^: Installation in Restricted Access Location (RAL) A restricted access location is a designated area within an incident area (High or Low temperature environment) With authorized people can enter for a period of time and for a specific purpose.

1. Access can only be gained by service people or by users who have been instructed about the reasons for the Restrictions applied to the location and about any precautions that shall be taken.
2. Access is through the use of a tool or lock and key, or other means of security, and is controlled by the authority Responsible for the location.



*Notes²: Please make sure that the power consumption is in the spec of the power supply output capability from AC adaptor (220W or 300W). Please choose the suitable AC adaptor for your application. AC/DC 24V/12.5A, 300W 3PIN Terminal Block Power Adaptor AC/DC 24V/9.16A, 220W 3PIN Terminal Block Power Adaptor



*Note³: The safety ambient operating temperature is 40 degree C if the external AC adapter model: EA12501J or EA13001N will be placed in the same high temperature area with the embedded system.



*Note⁴: In the PXE application, please install i219-LM driver in OS image in advance before installing OS via PXE server.



*Note⁵: CAUTION - Lithium battery is included in this embedded system. Please do not puncture, mutilate, or dispose of battery in fire. There will be danger of explosion if battery is incorrectly replaced. Replace only with the same or equivalent type recommended by manufacturer. Dispose of used battery according to manufacturer instructions and in accordance with your local regulations.



*Note⁶: The following configurations in ultimate use might cause system shut down unexpectedly.

- 12 x LANs or 10 x PoE LANs with some NVMe SSD models (Please check the available list with our sales contact window)
- 12 x LANs or 10 x PoE LANs with mPCIe or M.2 Wifi Card (Not include CNVi Wifi Card. Please check the available list with our sales contact window)



*Note^7^: Please read the BIOS release note before re-flashing BIOS. If the BIOS notes mention the BIOS will be loaded default after re-flashing BIOS, please check the BIOS setting again before boot up. For example, inconsistent RAID setting might cause system boot up issue.



*Note^8^: When ALDERAMIN MK3-D is installed with PCIe GFX card, the BIOS setup menu will only have display output via external graphic card.



*Note^9^: When ALDERAMIN MK3-D is installed with dual layer PCIe GFX card, it can only be installed with 1 internal HDD/SSD (not include removable HDD/SSD) instead of 2 due to mechanical limitation. The SATA cable connector needs to insert to the SATA connector beside the 2*40x40x20mm internal system fan. The cable clip might also need to be removed due to mechanical concern with GFX card.



*Note^10^: When ALDERAMIN MK3-D is installed with NVIDIA T4 or P4 AI card, 2*40x40x28mm internal system fan, and fan duct, it can only be installed with 1 internal HDD/SSD (not include removable HDD/SSD) instead of 2 in avoid of fan duct interference. The SATA cable connector needs to insert to the internal SATA connector.

1.5 Mechanical Specification

1.5.1 ALDERAMIN MK3

- Mechanical Dimension: 268 mm x 246 mm x 108 mm
- PCI Express x16 Slot Maximum Card Dimension:
 - 111.15 x 200 x 18.7mm with mPCIe PoE Module
 - 111.15 x 230 x 18.7mm w/o mPCIe PoE Module

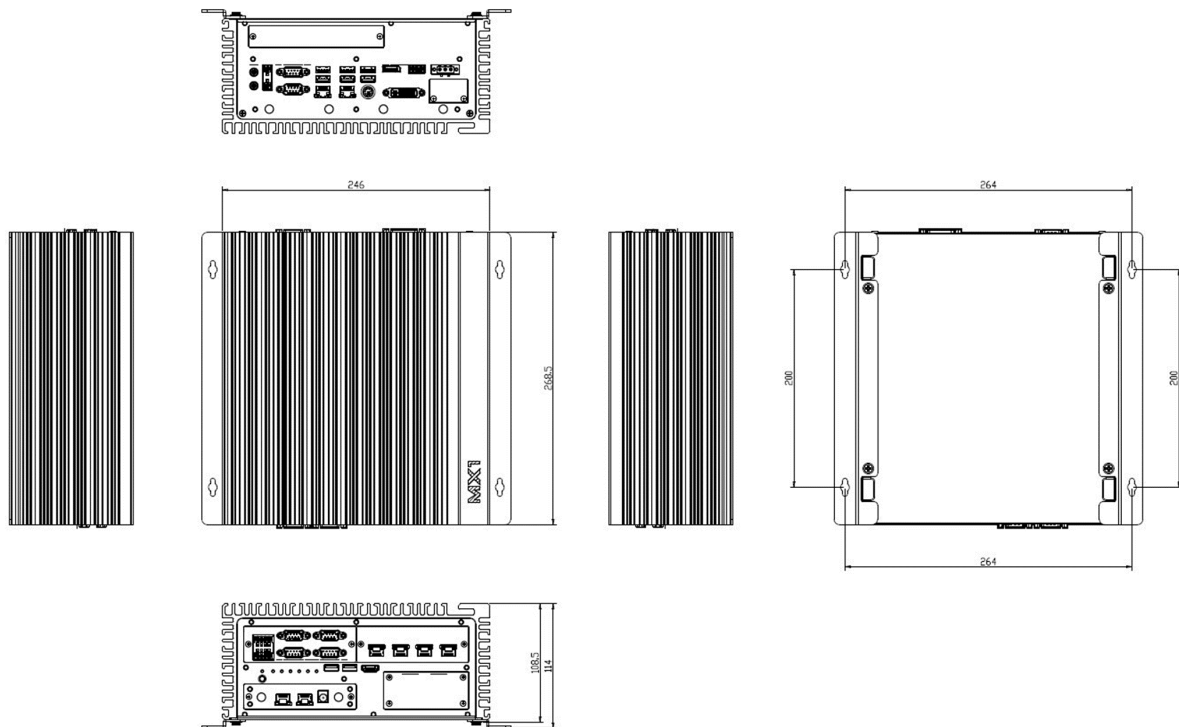

1.5.2 ALDERAMIN MK3-D

- Mechanical Dimension: 268 mm x 246 mm x 128 mm
- PCI Express x16 Slot Maximum Card Dimension: 145 x 221 x 43mm w/o mPCIe PoE Module
- PCI Express X16 + X1 Dual Slot (Default)
- PCI Express X8 + X8 Dual Slot (Optional)
- AI / Graphic Card Support List
 - NVIDIA Quadro P400 (30W)
 - NVIDIA Quadro P620 (40W)
 - NVIDIA Quadro P2000 (75W)
 - Nvidia Tesla T4 / P4 (75W)
 - Aetina GTX1050 N1050-J9FX, 2GB (75W)
 - Leadtek WinFast GTX1650, 4GB (75W)
 - Leadtek WinFast GTX1660 HURRICANE, 6GB (120W) with 2nd 12V, 180W AC Adaptor
 - Leadtek WinFast GTX1660 Ti HURRICANE, 6GB (120W) with 2nd 12V, 180W AC Adaptor

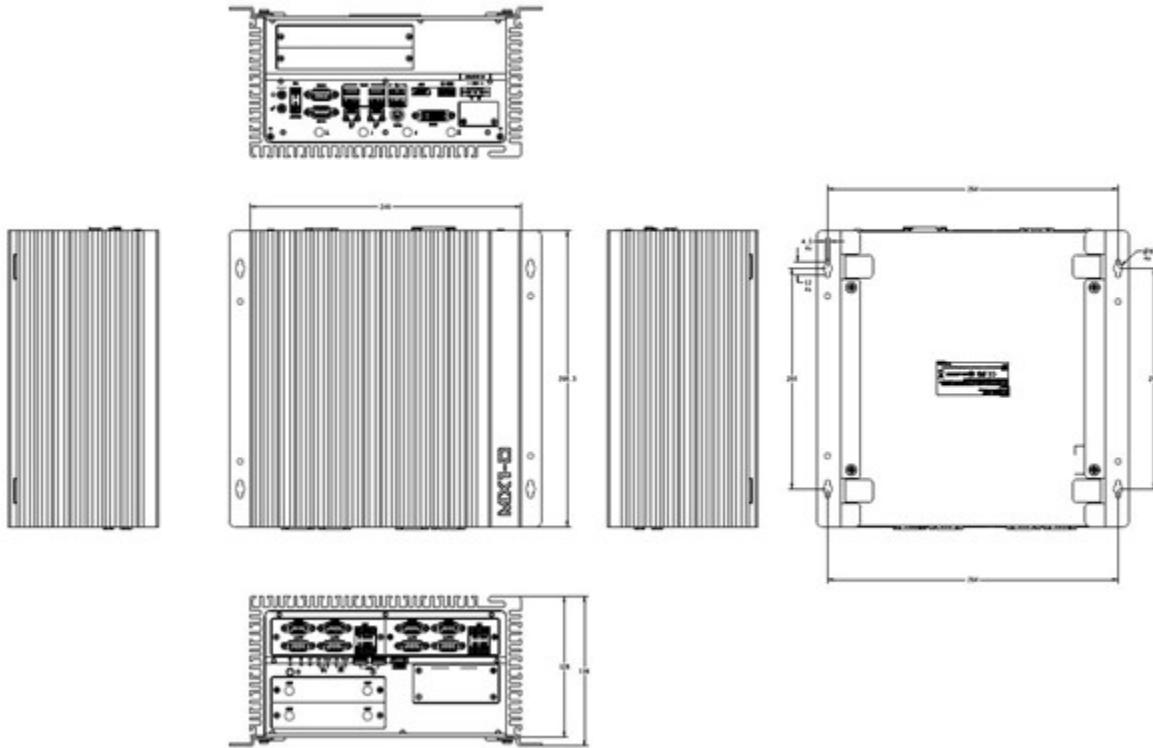

1.6 System I/O Placement

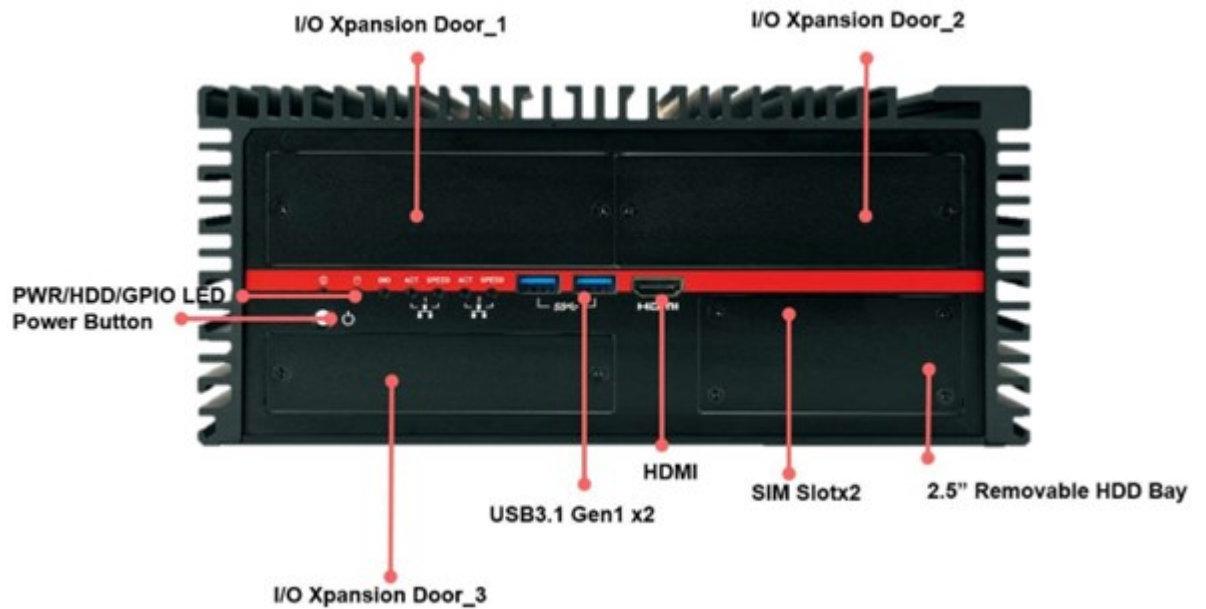

● Front I/O:

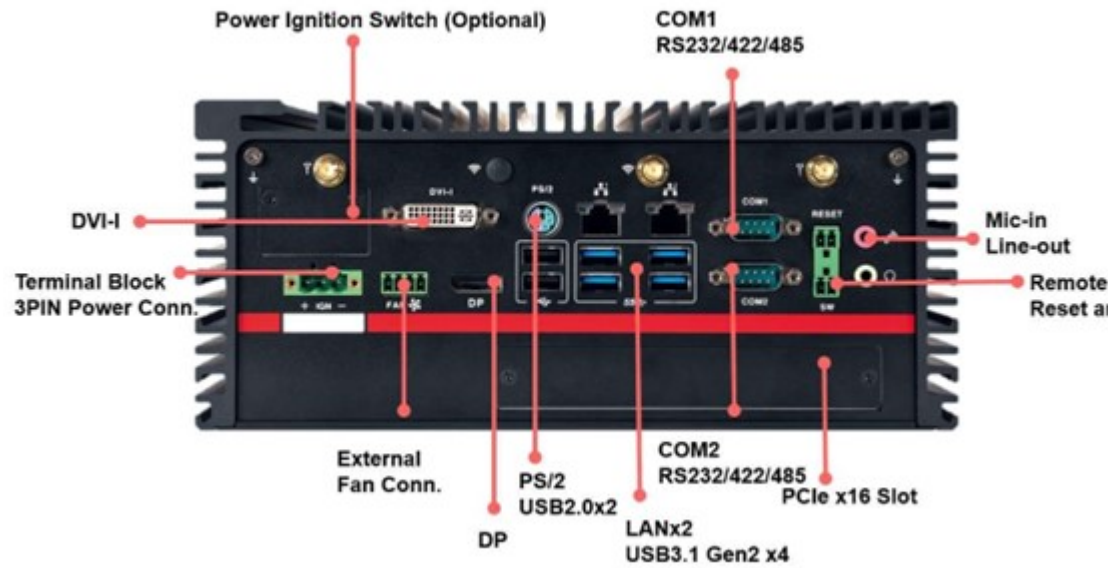

- Rear I/O (ALDERAMIN MK3):

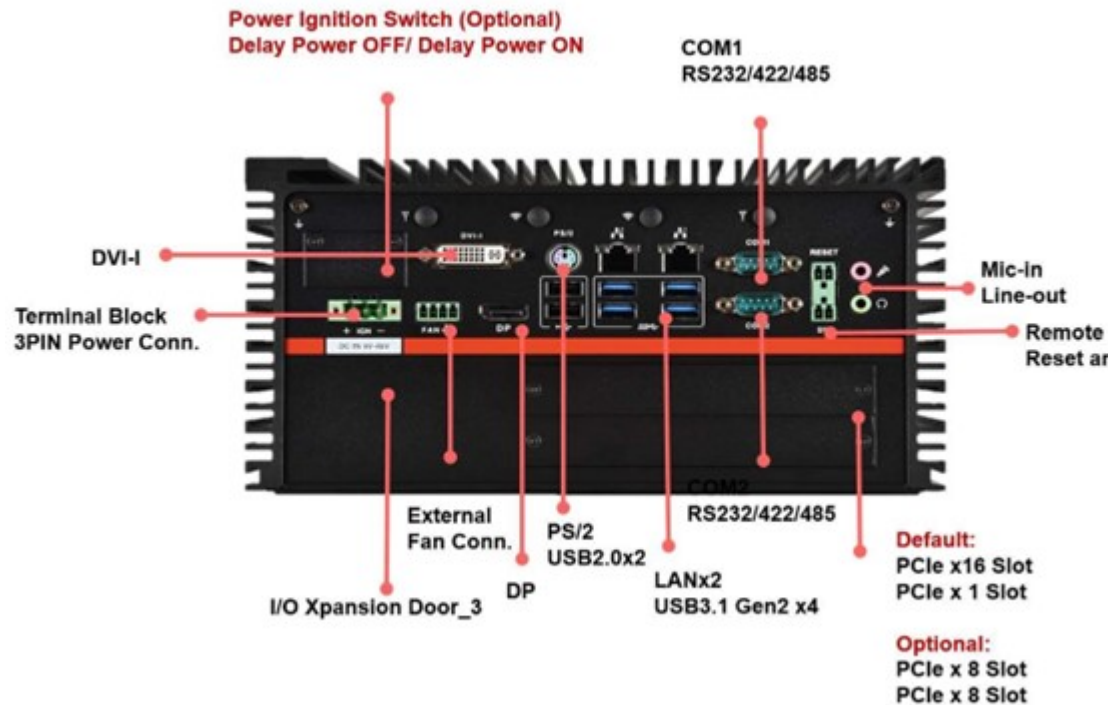

- Rear I/O (Alderamin-MK3D):

*Notes: The recommended dimension of USB cable connector or device for USB2.0 ports is 9mm height x 19mm width when all the other I/O ports are occupied. It still needs to depend on the DisplayPort connector and other devices' dimension to avoid the interference.

- Expansion Module (Optional) Configuration Table



Expansion	Function	1	2	3	4
COM/DIO	4x COM, 8x DIO	X	X		
PoE RJ45	4x Gigabit PoE RJ45	X	X		
PoE M12	4x Gigabit PoE M12	X	X		
IGN	Ignition Control				X
DualLAN	2x Gigabit LAN RJ45	X	X	X	

1.7 Recommended PoE Configuration and Environmental Spec Matrix

CPU TDP	PoE Configuration	Max. Ambient	CPU Util-ity	Memory Loading	HDD/SSD Loading	PoE Power%
71W~80W	None	40	70%	40%	10%	-
71W~80W	x 2 port PoE (Max. 30W)	35	70%	40%	10%	70%
71W~80W	x 4 port PoE (Max. 50W)	30	70%	40%	10%	70%
51W~65W	None	50C	70%	40%	10%	-
51W~65W	x 2 port PoE (Max. 30W)	45C	70%	40%	10%	70%
51W~65W	x 4 port PoE (Max. 50W)	40C	70%	40%	10%	70%
51W~65W	x 6 port PoE (Max. 80W)	35C	50%	40%	10%	70%
51W~65W	x 8 port PoE (Max. 100W)	30C	50%	40%	10%	70%
35W	None	70C	100%	40%	10%	-
35W	x 2 port PoE (Max. 30W)	65C	100%	40%	10%	70%
35W	x 4 port PoE (Max. 50W)	60C	100%	40%	10%	70%
35W	x 6 port PoE (Max. 80W)	55C	100%	40%	10%	70%
35W	x 8 port PoE (Max. 100W)	50C	100%	40%	10%	70%
35W	x 10 port PoE (Max. 130W)	45C	100%	40%	10%	70%

2 Regulatory Compliances

2.1 CE and UKCA Notice

This device complies with the requirements of the CE directive and UKCA regulations.

Low Voltage Directive 2014/35/EU + Electrical Equipment Safety Regulations 2016 (SI 2016 No 1101)

- EN 62368-1:2014+AC:2015

EMC Directive 2014/30/EU + Electromagnetic Compatibility Regulations 2016

- EN 50155:2017
- EN 50121-1:2017
- EN 50121-3-2:20L4
- EN 61000-3-2:2016
- EN 61000-3-3:2013
- EN 61000-4-222009
- EN 61000-4-3:2006 +A1:2008 +A2:2010
- EN 61000-4-4220L2
- EN 61000-4-5:2014 +A1:2017
- EN 61000-4-6:2014 +AC:2015

RoHS 2 Directive 2011/65/EU & 2015/863/EU + RoHS 2 Directive 2020 No. 1647

- Exemption(s) used:
- 6c,7a,7c-l



2.2 Railway Application and Environmental Testing

Railway Applications

- EN 50155:2017
- IEC 61373:2010
- EN 50121-3-2:2016

Environmental Testing

- IEC 60068-2-1:2017
- IEC 60068-2-2:2017
- IEC 60068-2-30:2005

Fire Hazard Testing

- EN60695-2-11:2014

3 DIP Switch settings and pin definition

This chapter provides information about how to set up the dip switch, and use internal I/Os of ALDERAMIN MK3 Embedded System hardware.

3.1 Jumper and Internal Connector Overall Placement

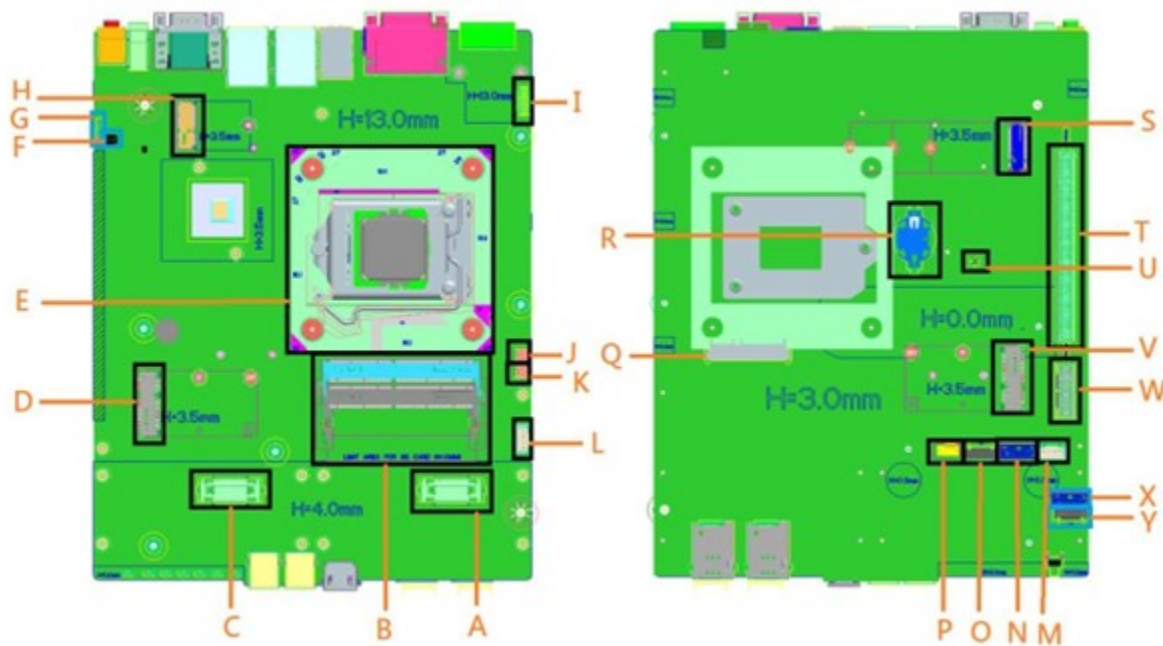

A	1st Board to Board connector
B	DIMM sockets
C	2nd Board to Board connector
D	Mini PCIe slot 2
E	CPU socket
F	DIP Switch for Power COM
G	AT/ATX mode switch
H	M.2 KEY E connector
I	Board to Board connector for power Ignition
J	5V power header
K	5V power header
L	12V power header for POE module of Mini PCIe
M	12V power header for POE module of Mini PCIe
N	2nd SATA Signal Header
O	2nd SATA Power Header
P	FAN Header
Q	1ST SATA Connector
R	Coin Battery Connector
S	M.2 KEY M
T	PCIE X16
U	Clear CMOS switch
V	Mini PCIe Slot 1
W	PCIE X1
X	3rd SATA Signal Header
Y	3rd SATA Power Header

3.2 DIP Switch Setting

- Location #G



Pin	Signal
UP	ATX mode
Down	AT mode

- Location #F

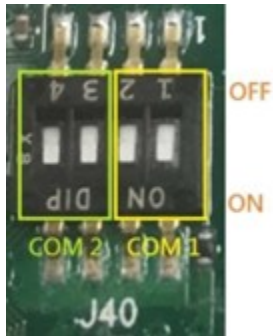

Switch setting	Mode	1	2
1-2 → COM 1	RI	ON	ON
	5V	ON	OFF
	12V	OFF	ON
Switch setting	Mode		
3-4 → COM 2	RI	ON	ON
	5V	ON	OFF
	12V	OFF	ON

3.3 Internal Connector Pin Definition

3.3.1 Location #Q - 1st SATA Connector



Pin	Signal Name
P1	VCC3
P2	VCC3
P3	VCC3
P4	GND
P5	GND
P6	GND
P7	VCC
P8	VCC
P9	VCC
P10	GND
P11	RES
P12	GND
P13	+12V
P14	+12V
P15	+12V
S1	GND
S2	SATAHDR_TXP0_C
S3	SATAHDR_TXN0_C
S4	GND
S5	SATAHDR_RXN0_C
S6	SATAHDR_RXP0_C
S7	GND

3.3.2 Location #O/#Y - 2nd and 3rd SATA Power Header

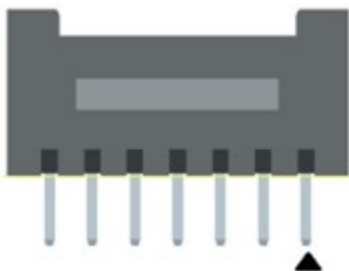

Pin	Signal Name
1	VCC3
2	GND
3	VCC
4	VCC
5	GND
6	+12V
7	+12V

3.3.3 Location #N/#X - 2nd and 3rd SATA Signal Header



Pin	Signal Name	Description
1	GND	Ground
2	SATAHDR_TXP_C	SATA DATA Transmit(positive)
3	SATAHDR_TXN_C	SATA DATA Transmit(negative)
4	GND	Ground
5	SATAHDR_RXN_C	SATA DATA Receive(negative)
6	SATAHDR_RXP_C	SATA DATA Receive(positive)
7	GND	Ground
8	G1	GND
9	G2	GND

3.3.4 Location #P – Fan Header

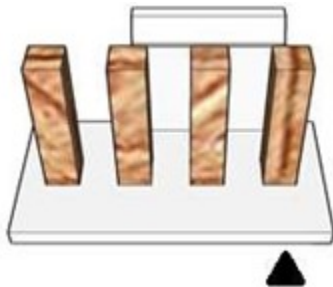

Pin	Signal
1	Ground
2	+12V
3	CPU_FAN_TACH
4	CPU_FAN_CTRL

3.3.5 Location #H – M.2 Key E Slot



	Standard M.2 Key E	LcP Signals	LcP Signals	Standard M.2 Key E	
74	+V3P3A		GND		75
72	+V3P3A		WT_CLKP	REFCLKN1	73
70	PEWake1# (IO)(0/3.3V)		WT_CLKN	REFCLKP1	71
68	CLKREQ1# (IO)(0/3.3V)		GND		69
66	PERST1# (O)(0/3.3V)		WT_D0P	PERn1	67
64	RESERVED	REFCLK0 (I)(1V @38.4MHz)	WT_D0N	PERp1	65
62	ALERT# (I)(0/1.8)	A4WP_IRQ#	GND		63
60	I2C_CLK (O)(0/1.8V)	A4WP_I2C_CLK	WT_D1P	PETn1	61
58	I2C_DATA (IO)(0/1.8)	A4WP_I2C_DATA	WT_D1N	PETp1	59
56	W_DISABLE1# (O)(0/3.3V)		GND		57
54	W_DISABLE2# (O)(0/3.3V)		PEWake0# (IO)(0/3.3V)		55
52	PERST0# (O)(0/3.3V)		CLKREQ0# (IO)(0/3.3V)		53
50	SUSCLK(32kHz) (O)(0/3.3V)	C_P32K (3.3V Tolerant)	GND		51
48	COEX_TXD (O)(0/1.8V)		REFCLKNO		49
46	COEX_RXD (O)(0/1.8V)		REFCLKPO		47
44	COEX3 (IO)(0/1.8V)		GND		45
42	CLink CLK		PERn0		43
40	CLink DATA		PERp0		41
38	CLink RESET (O)(0/3.3V)		GND		39
36	LPSS UART RTS (O)(0/1.8V) / BRI_DT (MUX'd in PCH/SoC)		PETn0		37
34	LPSS UART CTS (I)(0/1.8V) / RGI_RSP (MUX'd in PCH/SoC)		PETp0		35
32	LPSS UART Tx (O)(0/1.8V) / RGI_DT (MUX'd in PCH/SoC)		GND		33
E	Connector Key		Connector Key		E
	Connector Key		Connector Key		
	Connector Key		Connector Key		
	Connector Key		Connector Key		
22	LPSS UART Rx (I)(0/1.8V) / BRI_RSP (MUX'd in PCH/SoC)		WGR_CLKP	SDIO Reset#(O)(0/1.8V)	23
20	UART Wake# (I)(0/3.3V)		WGR_CLKN	SDIO Wake#(I)(0/1.8V)	21
18	GND	GND/LNA_EN (LcP Production)	GND	SDIO DAT3(IO)(0/1.8V)	19
16	LED2# (I)(OD)		WGR_D0P	SDIO DAT2(IO)(0/1.8V)	17
14	PCM_OUT (O)(0/1.8V) / CLKREQ0 (MUX'd in PCH/SoC)		WGR_D0N	SDIO DAT1(IO)(0/1.8V)	15
12	PCM_IN (I)(0/1.8V)		GND	SDIO DAT0(IO)(0/1.8V)	13
10	PCM_SYNC (OI)(0/1.8V) / RF_RESET_B (MUX'd in PCH/SoC)		WGR_D1P	SDIO CMD(IO)(0/1.8V)	11
8	PCM_CLK (OI)(0/1.8V)		WGR_D1N	SDIO CLK(O)(0/1.8V)	9
6	LED1# (I)(OD)		GND		7
4	+V3P3A		USB_D-		5
2	+V3P3A		USB_D+		3
			GND		1

3.3.6 Location #S – M.2 Key M Slot

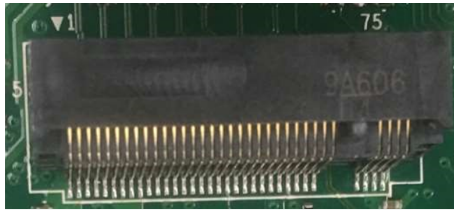

74	1.3Vaux	GND	75
72	1.3Vaux	GND	73
70	1.3Vaux	GND	71
68	SUSCLK(32kHz) (O)(0/3.3V)	PEDET (OC-PCIe/GND-SATA)	69
	Key	N/C	67
	Key	Key	
	Key	Key	
	Key	Key	
	Key	Key	
58	N/C	GND	57
56	N/C	REFCLKP	55
54	PEWake# (IO)(0/3.3V) or N/C	REFCLKN	53
52	CLKREQ# (IO)(0/3.3V) or N/C	GND	51
50	PERST# (O)(0/3.3V) or N/C	PERp0/SATA-A+	49
48	N/C	PERn0/SATA-A-	47
46	N/C	GND	45
44	N/C	PETp0/SATA-B-	43
42	N/C	PETn0/SATA-B+	41
40	N/C	GND	39
38	DEVS LP (O)(0/3.3V)	PERp1	37
36	N/C	PERn1	35
34	N/C	GND	33
32	N/C	PETp1	31
30	N/C	PETn1	29
28	N/C	GND	27
26	N/C	N/C	25
24	N/C	N/C	23
22	N/C	GND	21
20	N/C	N/C	19
18	1.3Vaux	N/C	17
16	1.3Vaux	GND	15
14	1.3Vaux	N/C	13
12	1.3Vaux	N/C	11
10	DAS/DSS# (I)(OD)	GND	9
8	N/C	N/C	7
6	N/C	N/C	5
4	1.3Vaux	GND	3
2	1.3Vaux	GND	1

3.3.7 Location #L/#M – 12V Power Header for PoE Xpansion



Pin	Signal
1	Ground
2	+12V
3	+12V
4	GND

3.3.8 Location #J/#K – 5V Power Header for Reservation



Pin	Signal
1	+5V
2	Ground

3.4 External Connector Pin Definition

3.4.1 3-pin terminal block for DC Input



Pin	Signal
1	DC IN +9~48VIN
2	Ignition (IGN)
3	GND

3.4.2 4-pin Terminal Block for PWM Fan



Pin	Signal
1	Ground
2	+12V
3	System_FAN_TACH
4	SYSTEM_FAN_CTRL

3.4.3 2-pin Terminal Block for Remote Power ON/OFF and Re-set



Pin	Signal
1	Ground
2	EXT Reset
3	Ground
4	EXT_PWRBT_ON/OFF

3.4.4 COM#1 / COM#2

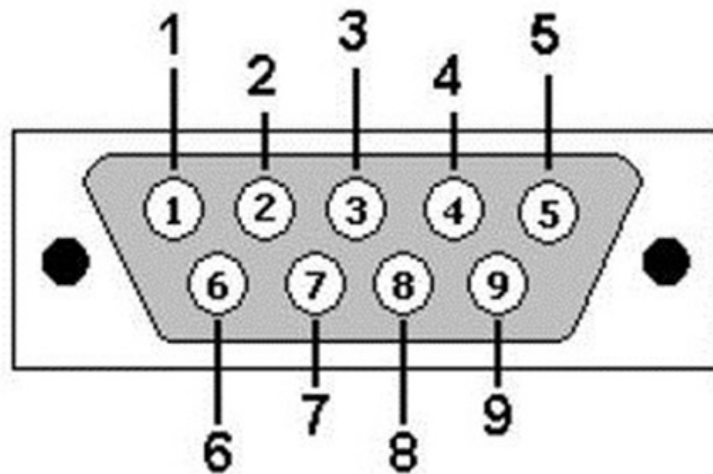

Pin No	RS-232	RS-422	RS-485
1	DCD	TX-	DATA-
2	RX	TX+	DATA+
3	RTX	RX-	NC
4	DTR	RX+	NC
5	GND	GND	GND
6	DSR	NC	NC
7	RTS	NC	NC
8	CTS	NC	NC
9	RI	NC	NC

3.5 Expansion Module COM/DIO

This Module consists of two parts, one is Serial COM, and the other is Digital IO function. Please see the guideline about how to set up this Module correctly.

3.5.1 COM Port Setting

a. Location

It has total 4 x COM port. These COM ports can be set to be RS232/RS485/RS422 or powered RS232. The position is as follows (A/B/C/D).

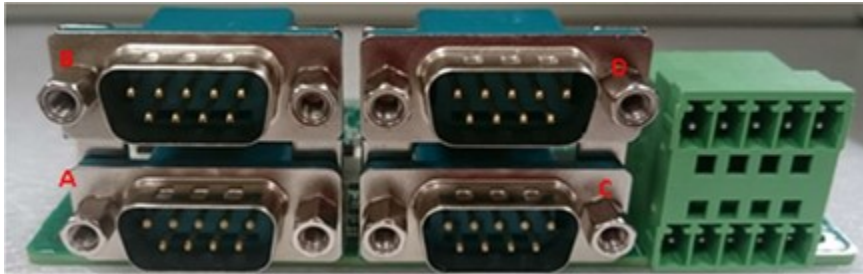

b. Dip Switch Function

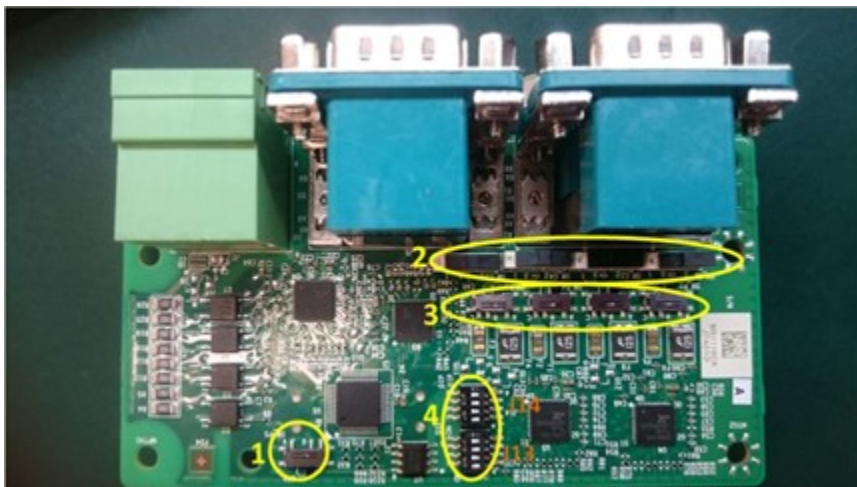

(1) COM ID selection switch



Set A-B; COM ID is determined by UART controller (default). Set B-C; COM ID is determined by EEPROM.

(2) Powered COM enable switch

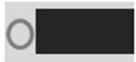

Set to the right(default)
Normal COM port (Pin9 = signal)

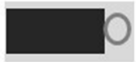

Set to the left
Powered COM port (Pin9 = VDD)

(3) Powered COM power source selection switch



Set A-B; VDD = 12V (Default)
Set B-C; VDD = 5V

(4) COM Mode setting switch

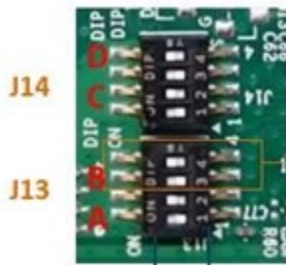

Example: This group of switch controls port B



Set on the digital side = 1
Set on the ON side = 0

Switch	Bit	COM Port	Test Mode	RS485	RS232 (Default)	RS422
J14	4	Port D	0	1	0	1
	3		0	0	1	1
	2	Port C	0	1	0	1
	1		0	0	1	1

Switch	Bit	COM Port	Test Mode	RS485	RS232 (Default)	RS422
J13	4	Port B	0	1	0	1
	3		0	0	1	1
	2	Port A	0	1	0	1
	1		0	0	1	1

3.5.2 Digital IO Port

It has total 8-bit GPIO, the position is as follows.

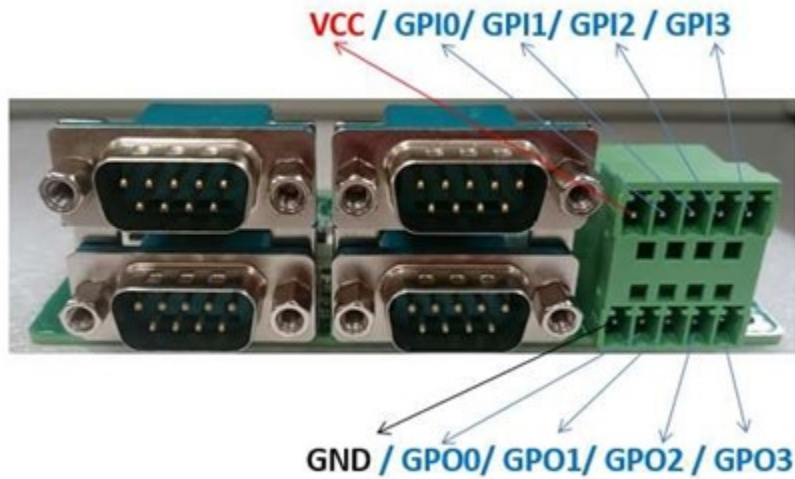

3.6 Expansion Module LAN

This Module is a Giga LAN module, which supports four M12 type interfaces.

3.6.1 M12 Code A LAN Module Pin definitions

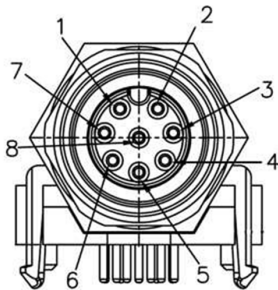

PIN	Signal	POE typeA
1	LAN_MDI1+	DC+
2	LAN_MDI1-	DC+
3	LAN_MD20+	DC-
4	LAN_MDI2-	
5	LAN_MDI3+	
6	LAN_MDI3-	DC-
7	LAN_MDI4+	
8	LAN_MDI4-	

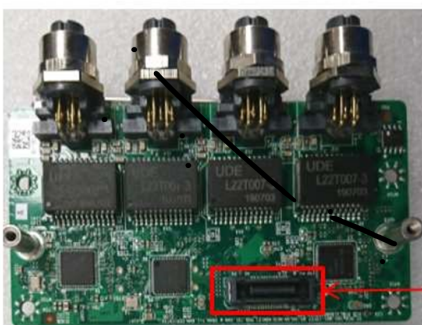

Use for connecting to MS-01PON-S10

3.7 Expansion Module IGN

This Module can detect vehicle ignition status and control the on/off delay time setting. This document is used to guide how to set up this power ignition module correctly.

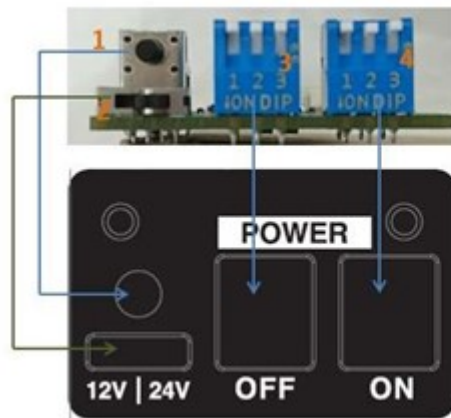

- (1) Emergency reset button
- (2) Input power selection switch
- (3) Power off delay switch
- (4) Power on delay switch

a. Location

b. Function

- Emergency reset button This button is for engineering use only. The host will be reset when this button is pressed.
- Input power selection switch Common car power supplies are DC 12V or 24V. Please set it according to your environment.

c. Delay Power On/Off Setting Switch This feature detects the ignition signal status and allows users to control the on/off delay time setting through DIP switch.



set on up side = 0



set on down side = 1

Power Off Delay Time Table

1	2	3	
0	0	0	0 second
0	0	1	1 minute
0	1	0	3 minutes
0	1	1	5 minutes
1	0	0	10 minutes
1	0	1	30 minutes
1	1	0	1 hour
1	1	1	2 hours

Power On Delay Time Table

1	2	3	
0	0	0	0 second
0	0	1	3 seconds
0	1	0	4 seconds
0	1	1	10 seconds
1	0	0	15 seconds
1	0	1	20 seconds
1	1	0	25 second
1	1	1	30 seconds

4 System Setup

This chapter provides information on setting up the ALDERAMIN MK3 Embedded System hardware.



Warning: The edge of the ALDERAMIN MK3 aluminum extrusion fins is sharp. Please be careful when moving the unit, installing it, and operating the embedded system!

4.1 2.5” SATA HDD/SSD Installation

Follow the instructions below to install a SATA HDD:

- Remove the door from the front bezel.

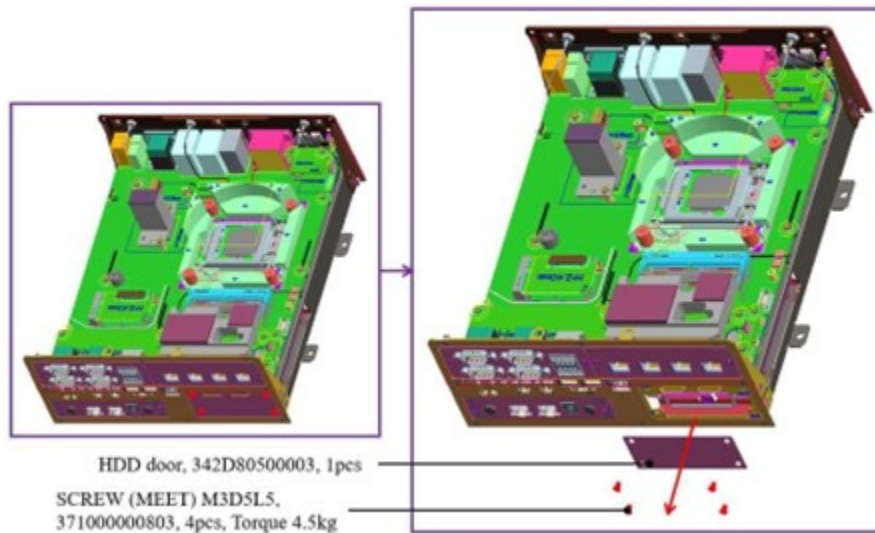

Note: After loosening the four screws from the expansion door, gently lift the cover with your fingernail and carefully remove the door from the front bezel.

- Pull the HDD tray out from the main chassis.

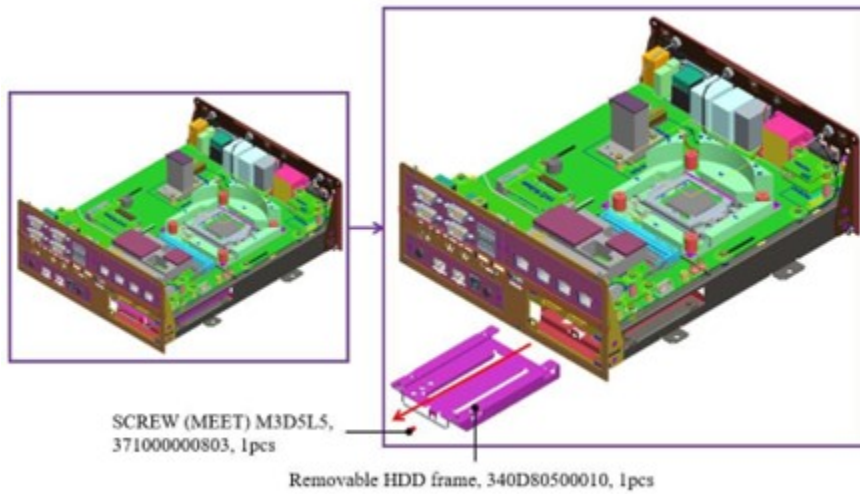

- Fasten the screws to secure the HDD/SSD to the bracket.

SCREW (MEET) M3D5L5, 371000000803, 4pcs, Torque 4.5kg
(Screw pack 452D80500003)

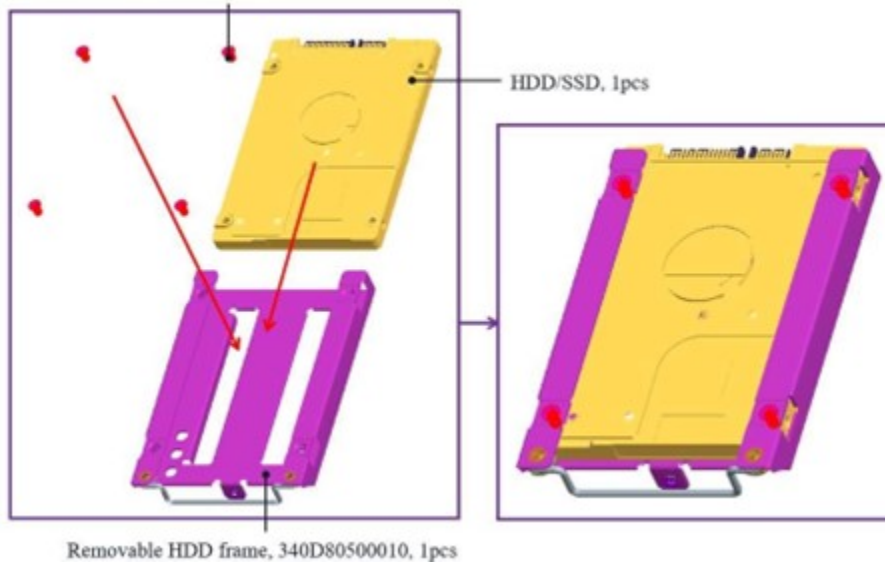

- Insert the HDD/SSD tray back into the main chassis and fasten the screws on the door.

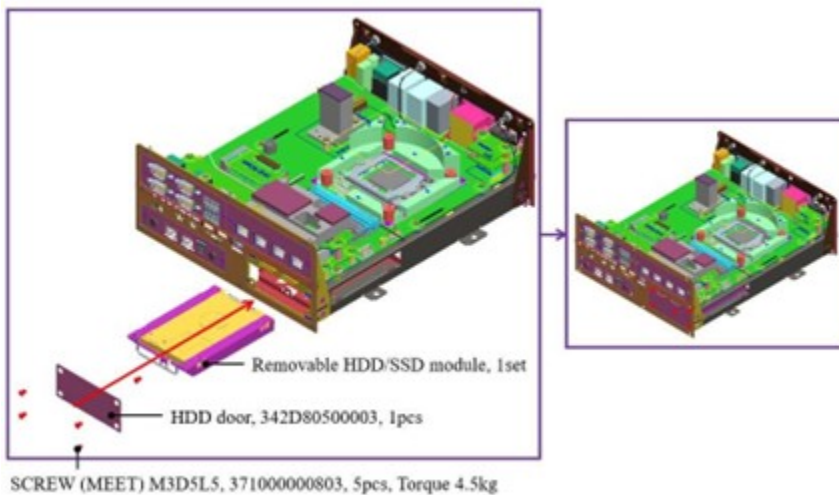

Note: Keep the unit horizontal to make it easier to insert the HDD tray back into the machine.

4.2 2nd and 3rd 2.5” SATA HDD/SSD Installation

- Remove the GND screws from the rear bezel.

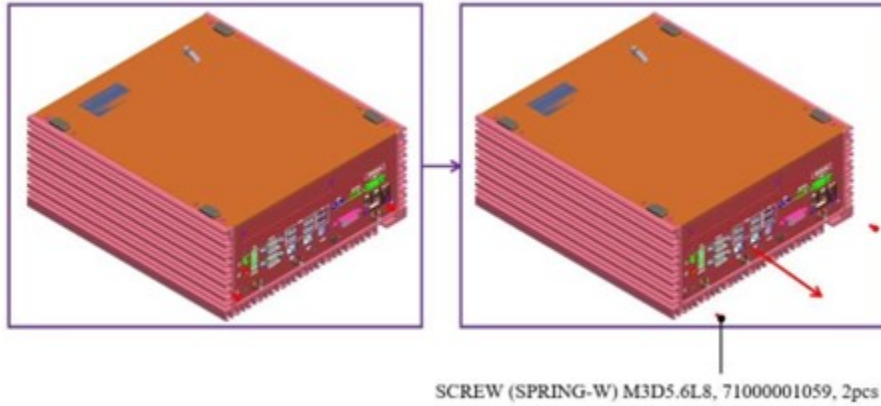

- Remove the bottom cover.

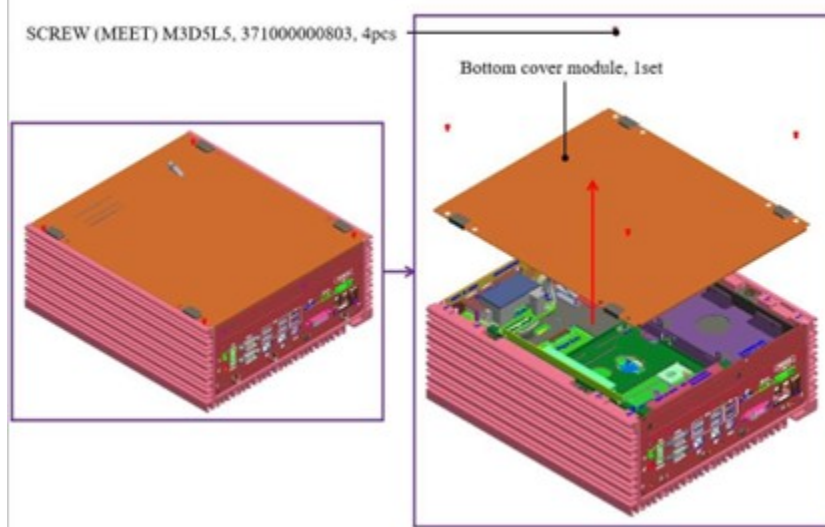

- Loosen the four HDD bracket screws and pull the bracket out of the unit.

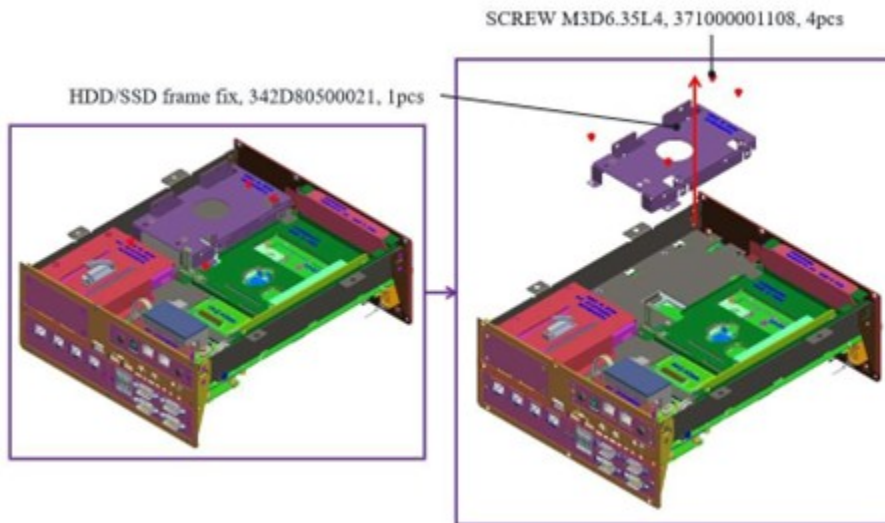

- Secure the 2nd and 3rd HDD/SSD to the bracket as shown in the concept drawing.

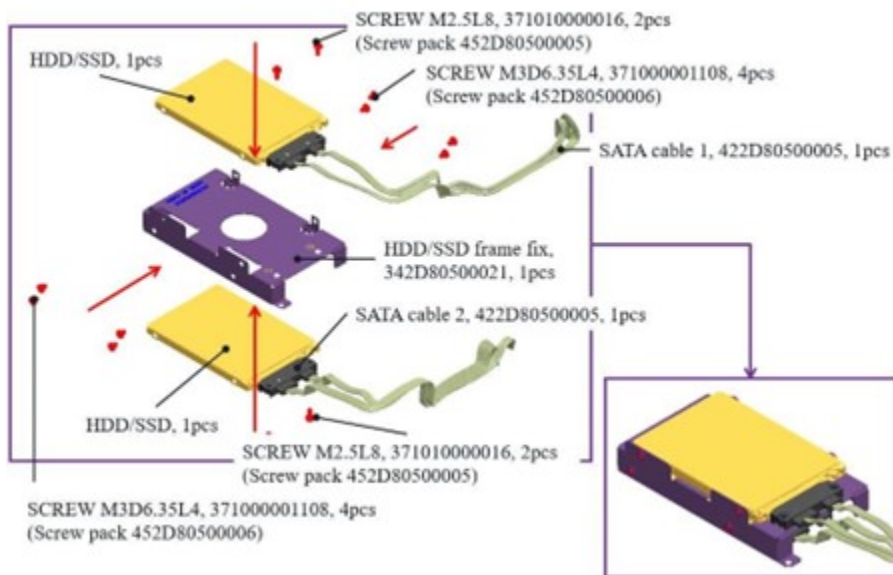

- Fasten the four bracket screws to the main unit.

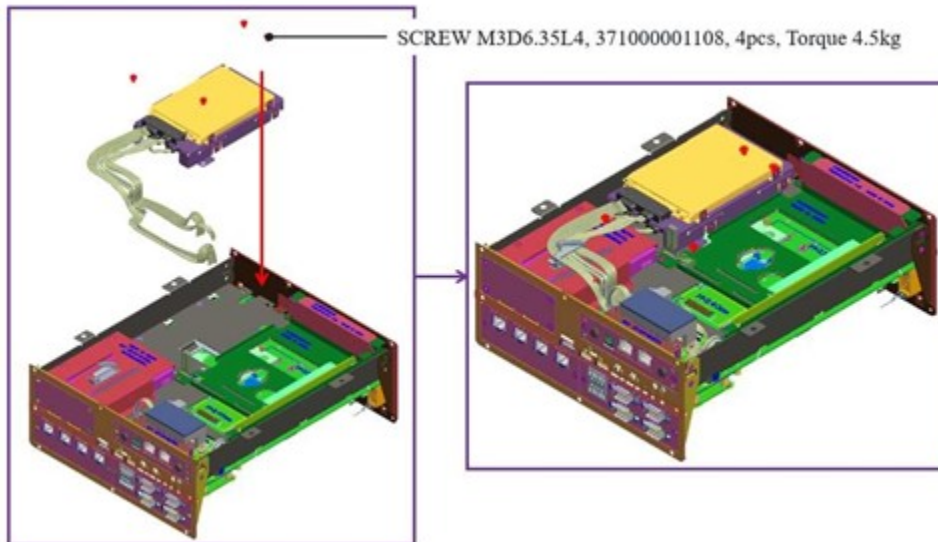

- Follow the drawing to route the SATA cables.

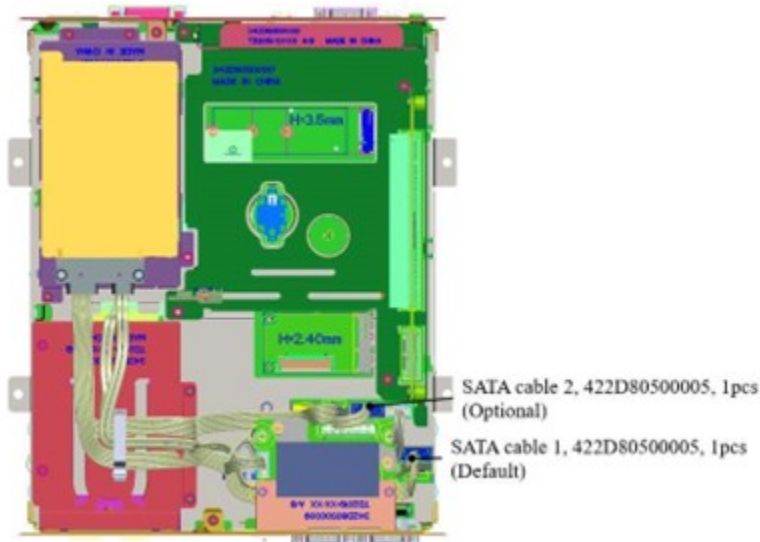

4.3 CPU/CPU Heatsink/DRAM Installation

- Remove the GND screws from the rear bezel.

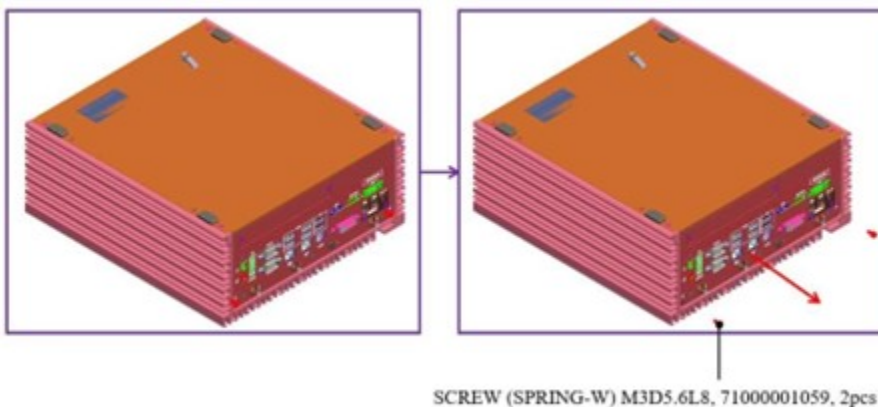

- Remove the bottom cover.

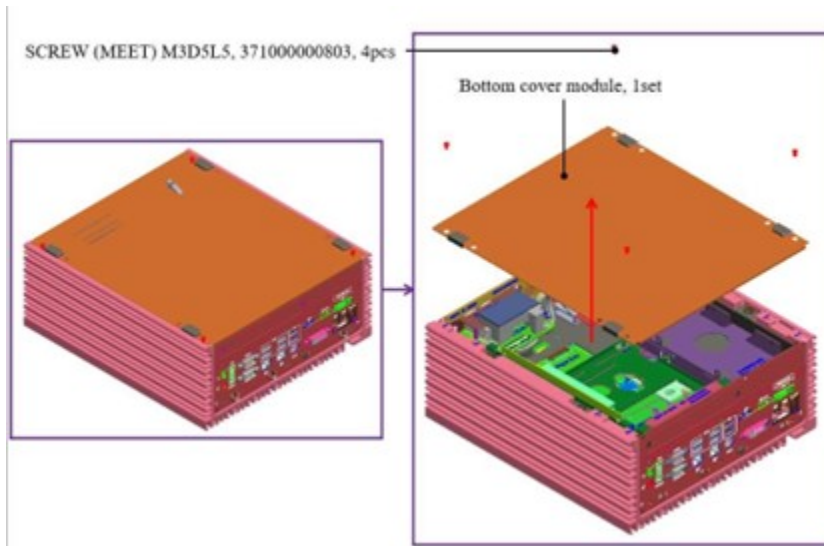

- Loosen the four M4 screws from the main chassis.

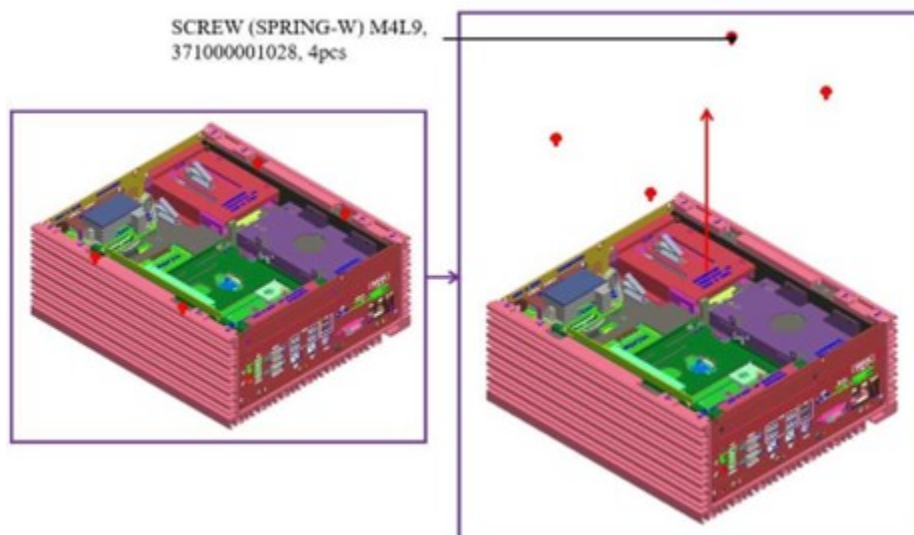

- Ensure that the two GND screws are loosened, then pull the main chassis from the aluminum extrusion. There are chipset thermal pads (L6) and two guide pins on the aluminum extrusion, so you will need to apply force to pull it out.

Warning: Be very careful of the sharp edges of the aluminum and metal parts when pulling the main chassis out.

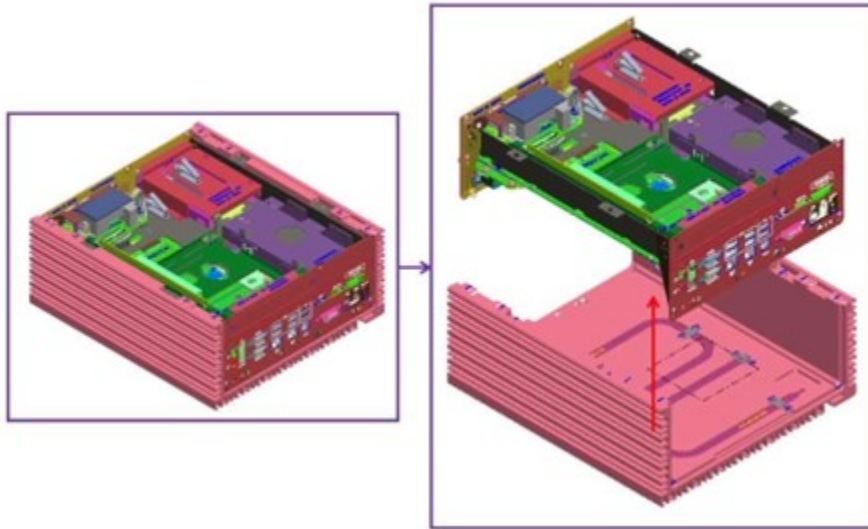

- Take the CPU passive cooler from the accessories and install the CPU, CPU heatsink, and DRAM modules as shown in the picture.

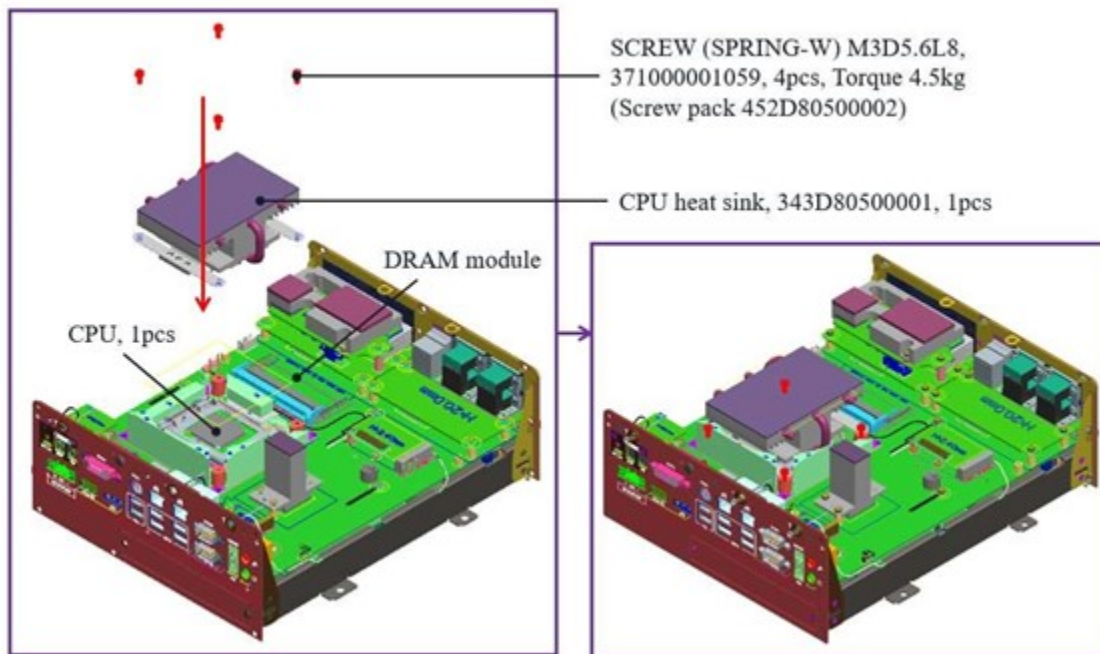

4.4 RTC Battery Maintenance

- Preparation for disassembly:

Flathead Screwdriver (The battery holder is designed for high vibration resistance and harsh environments, so a tool is needed to disassemble the coin battery)

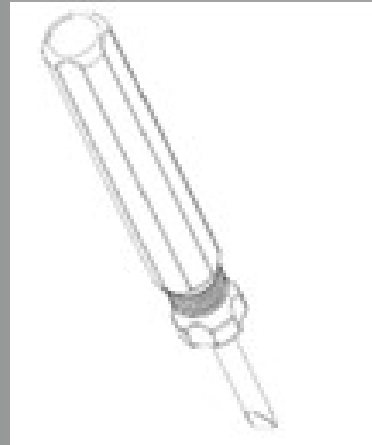

- Insert the flathead screwdriver into the gap on one side of the RTC battery vertically.

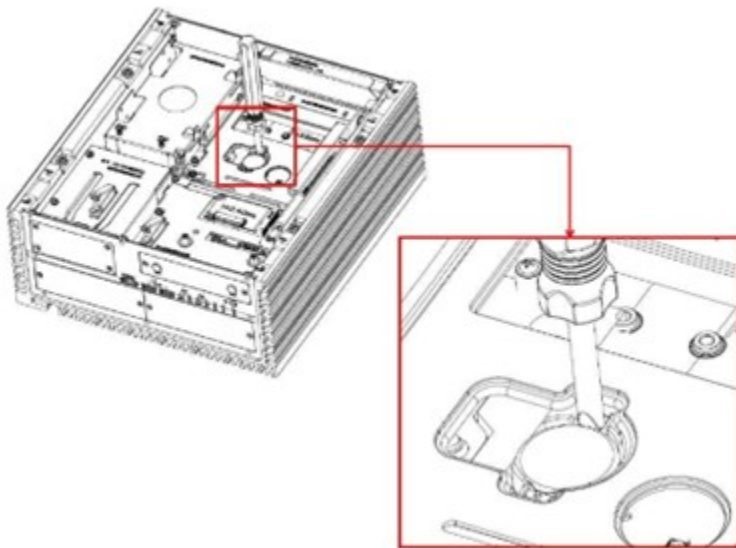

- Rotate the screwdriver about 45 degrees to loosen the coin battery.

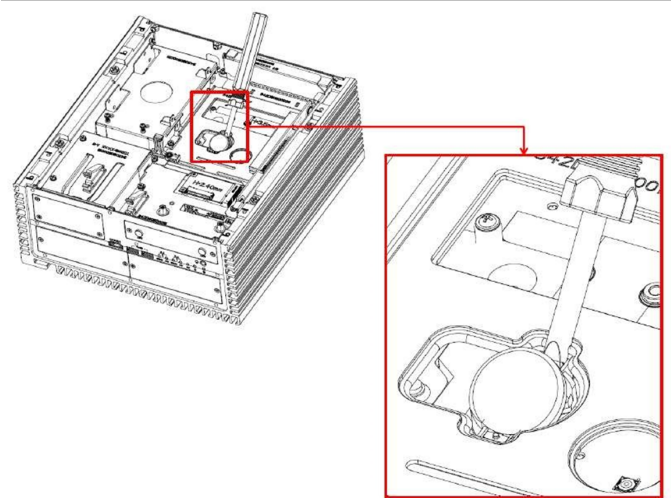
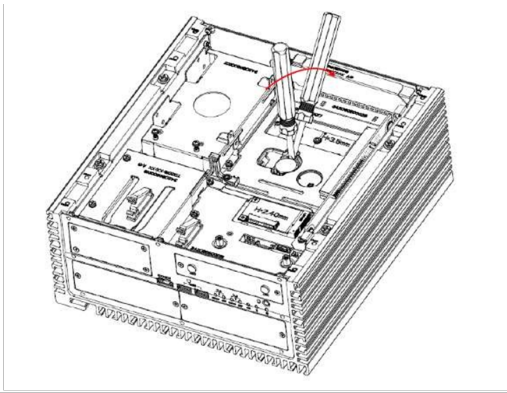

4.5 External Fan (Optional) Installation Guide

- Twist the thumbscrews counterclockwise on the external fan.

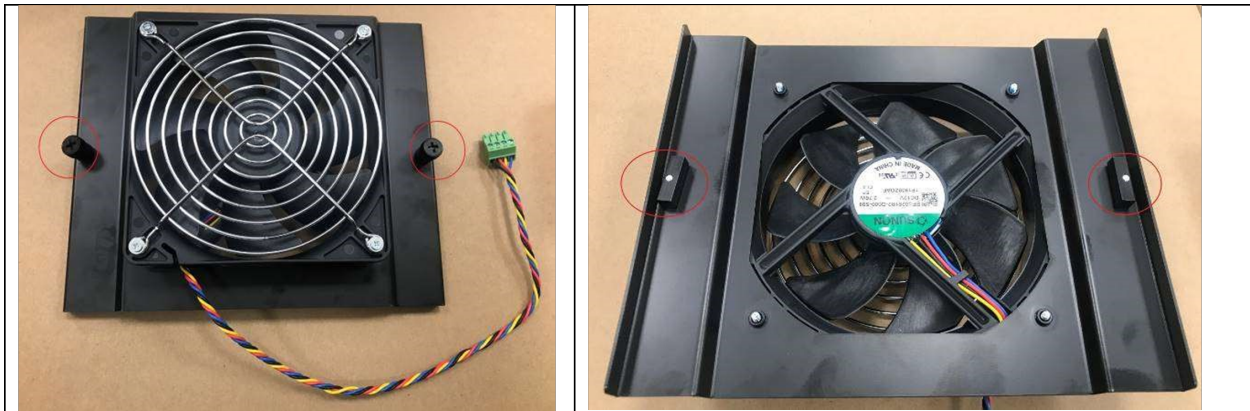

- Align the edge of the external fan bracket with the green arrows, and align the metal latch with the red arrow direction. Then insert the fan into the center of the housing.



- Tighten the thumbscrews to secure the external fan and connect the 4-pin cable to the PWM fan connector on the rear I/O.



Note: Do not operate the system when it is powered on. Improper installation of the external system fan bracket with the system powered on may cause injury.

5 BIOS Setup

This chapter provides information about how to set up BIOS and use BIOS menu items to adjust basic function settings.

5.1 Main Page

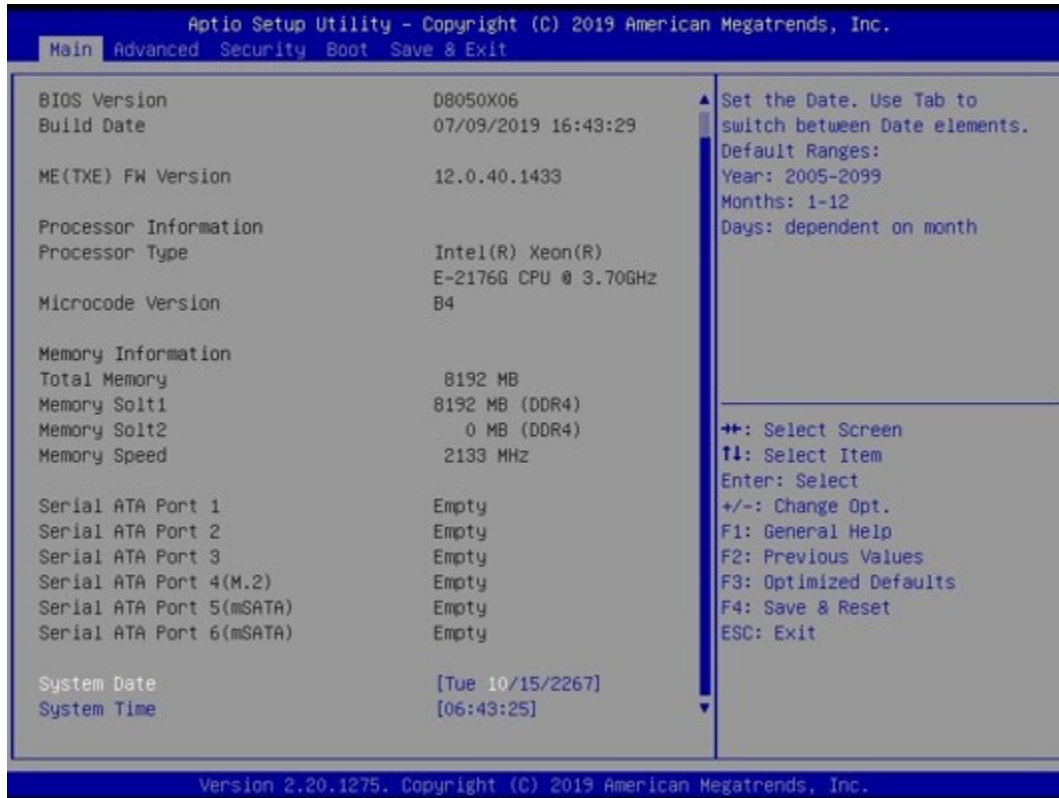

Field Name	Default Value	Comment
BIOS Vender	AMI Megatrends	This field is not selectable. There is no help text associated with it.
BIOS Version	Display the version of the BIOS	This field is not selectable. There is no help text associated with it.
Build Date	Display the build date of the BIOS	This field is not selectable. There is no help text associated with it.
ME (TXE) FW Version	ME Firmware Version	This field is not selectable. There is no help text associated with it.
Processor Information	Display the installed CPU brand	This field is not selectable. There is no help text associated with it.
Total Memory	Display the installed memory size	This field is not selectable. There is no help text associated with it.
Memory Frequence	Display the installed memory frequency	This field is not selectable. There is no help text associated with it.
SATA#1 / SATA#2 / SATA#3 / M.2#4 / mSATA#5 / mSATA#6	Display the installed SATA port device.	This field is not selectable. There is no help text associated with it.

Field Name	Default Value	Possible Value	Help
System Date	[Www mm/dd/yyyy]	Www: Mon/Tue/Wed/Thu/Fri/Sat/Sun mm: 1-12 dd: 1-31 yyyy: 1998-9999	Set the Date. Use Tab to switch between Date elements.
System Time	[hh/mm/ss]	hh: 0-23 mm: 0-59 ss: 0-59	Set the Time. Use Tab to switch between Time elements.

5.2 Advanced Page

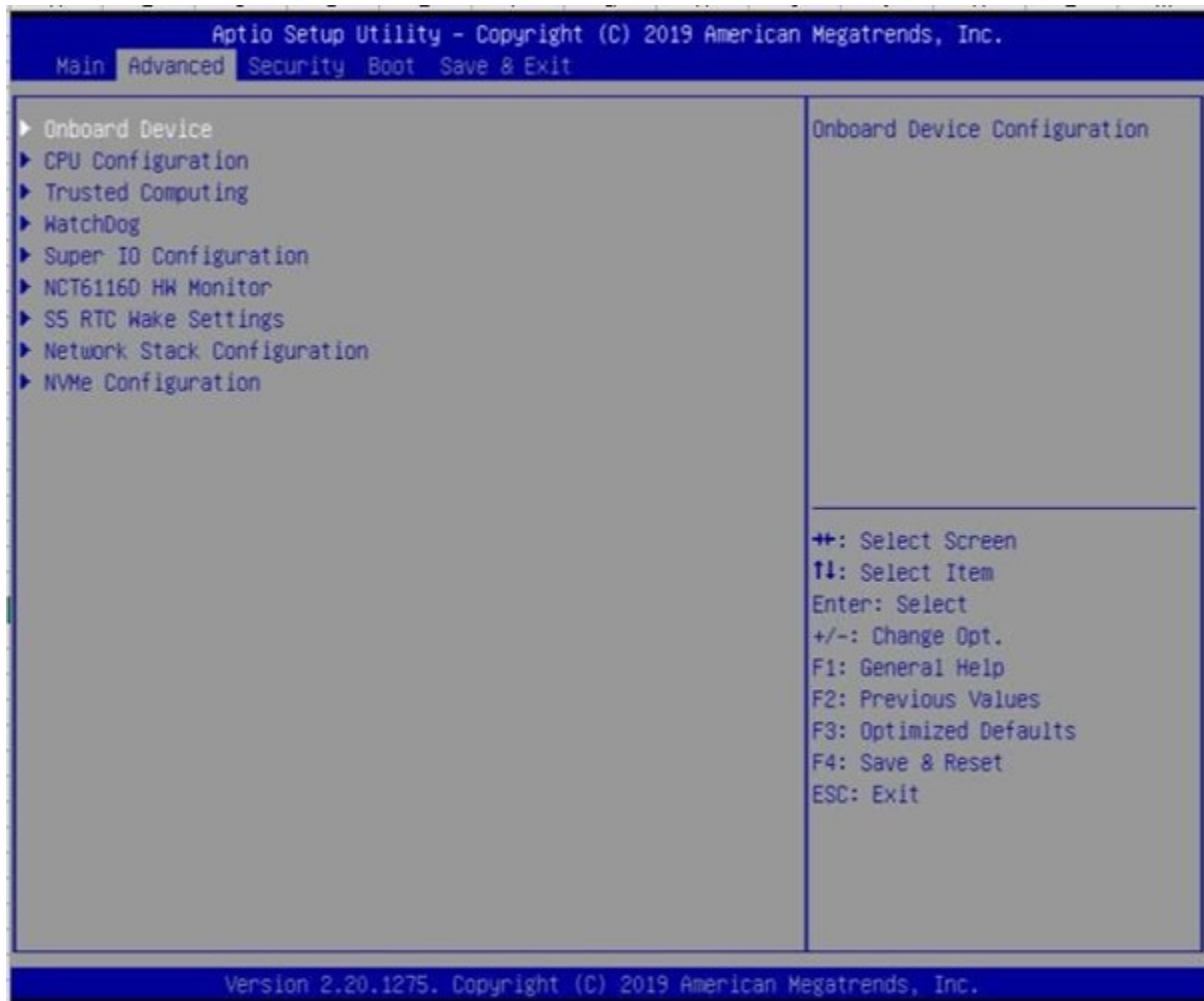

Advanced	Description
<input checked="" type="checkbox"/> Onboard Devices	Onboard Device Configuration
<input checked="" type="checkbox"/> CPU Configuration	CPU Configuration Parameters
<input checked="" type="checkbox"/> Trusted Computing	Trusted Computing Settings
<input checked="" type="checkbox"/> WatchDog	WatchDog Configuration
<input checked="" type="checkbox"/> Super IO Configuration	System Super IO Chip Parameters.
<input checked="" type="checkbox"/> NCT6116D HW Monitor	Monitor hardware status
<input checked="" type="checkbox"/> S5 RTC Wake Setting	Enable System to wake from S5 using RTC alarm
<input checked="" type="checkbox"/> Network Stack Configuration	Network Stack Settings
<input checked="" type="checkbox"/> NVMe Configuration	NVMe Device Options Settings

5.2.1 Onboard Device

Advanced		
Turbo Mode	[Enabled]	Enable/Disable processor Turbo Mode (requires Intel Speed Step or Intel Speed Shift to be available and enabled).
State After G3	[S5 State]	
DVMT Pre-Allocated	[64M]	
DVMT Total Gfx Mem	[256M]	
SATA Mode Selection	[AHCI]	
Wake on LAN Enable	[Enabled]	
HD Audio	[Enabled]	
		++: Select Screen ↑↓: Select Item Enter: Select +/-: Change Opt. F1: General Help F2: Previous Values F3: Optimized Defaults F4: Save & Reset ESC: Exit
Version 2.20.1275. Copyright (C) 2019 American Megatrends, Inc.		

☒ On-board Devices	Value	Onboard Device Configuration
Turbo Mode	Disabled / [Enabled]	Enable/Disable processor Turbo Mode (requires Intel Speed Step or Intel Speed Shift to be available and enabled).
State After G3	S0 State / [S5 State]	Specify what state to go to when power is re-applied after a power failure (G3 state).
DVMT Pre-Allocated	[64M] / 32M/F7 / 36M / 40M / 44M / 48M / 52M / 56M / 60M	Select DVMT 5.0 Pre-Allocated(Fixed) Graphics Memory size used by the Internal Graphics Device.
DVMT Total Gfx Mem	128MB / [256MB] /Max	Select DVMT5.0 Total Graphic Memory size used by the Internal Graphics Device.
SATA Mode Selection	[AHCI] / Intel RST Premium With Intel Optane System Acceleration	Determines how SATA controller(s) operate.
Wake on LAN Enable	[Enabled] / Disabled	Enable/Disable integrated LAN to wake the system.
HD Audio	Disabled / [Enabled]	Control Detection of the HD-Audio device. Disable = HAD will be unconditionally disabled Enabled = HAD will be unconditionally enabled.

5.2.2 CPU Configuration

Aptio Setup Utility - Copyright (C) 2019 American Megatrends, Inc.

Advanced

CPU Configuration		<p>Enables utilization of additional hardware capabilities provided by Intel (R) Trusted Execution Technology. Changes require a full power cycle to take effect.</p> <hr/> <p>++: Select Screen ↑↓: Select Item Enter: Select +/-: Change Opt. F1: General Help F2: Previous Values F3: Optimized Defaults F4: Save & Reset ESC: Exit</p>
Type	Intel(R) Xeon(R) E-2176G CPU @ 3.70GHz	
ID	0x906EA	
Speed	3700 MHz	
L1 Data Cache	32 KB x 6	
L1 Instruction Cache	32 KB x 6	
L2 Cache	256 KB x 6	
L3 Cache	12 MB	
L4 Cache	N/A	
VMX	Supported	
SMX/TXT	Supported	
Intel Trusted Execution Technology	[Disabled]	

Version 2.20.1275 Copyright (C) 2019 American Megatrends, Inc.

☒ CPU Configuration	Value	CPU Configuration Parameters
Type	Intel® xxxx® xxxxxx xxxxxxx	
ID	0XXXXX	
Speed	XXXX MHz	
L1 Data Cache	EX. 32KB x 2	
L1 Instruction Cache	EX. 32KB x 2	
L2 Cache	EX. 256KB x 2	
L3 Cache	EX. 3MB	
L4 Cache		
VMX	Supported	
SMX/TXT	Supported	
Intel Trusted Execution Technology	[Enabled] / Disabled	Enables utilization of additional hardware capabilities provided by Intel® Trusted Execution Technology. Changes require a full power cycle to take effect.

5.2.3 Trusted Computing

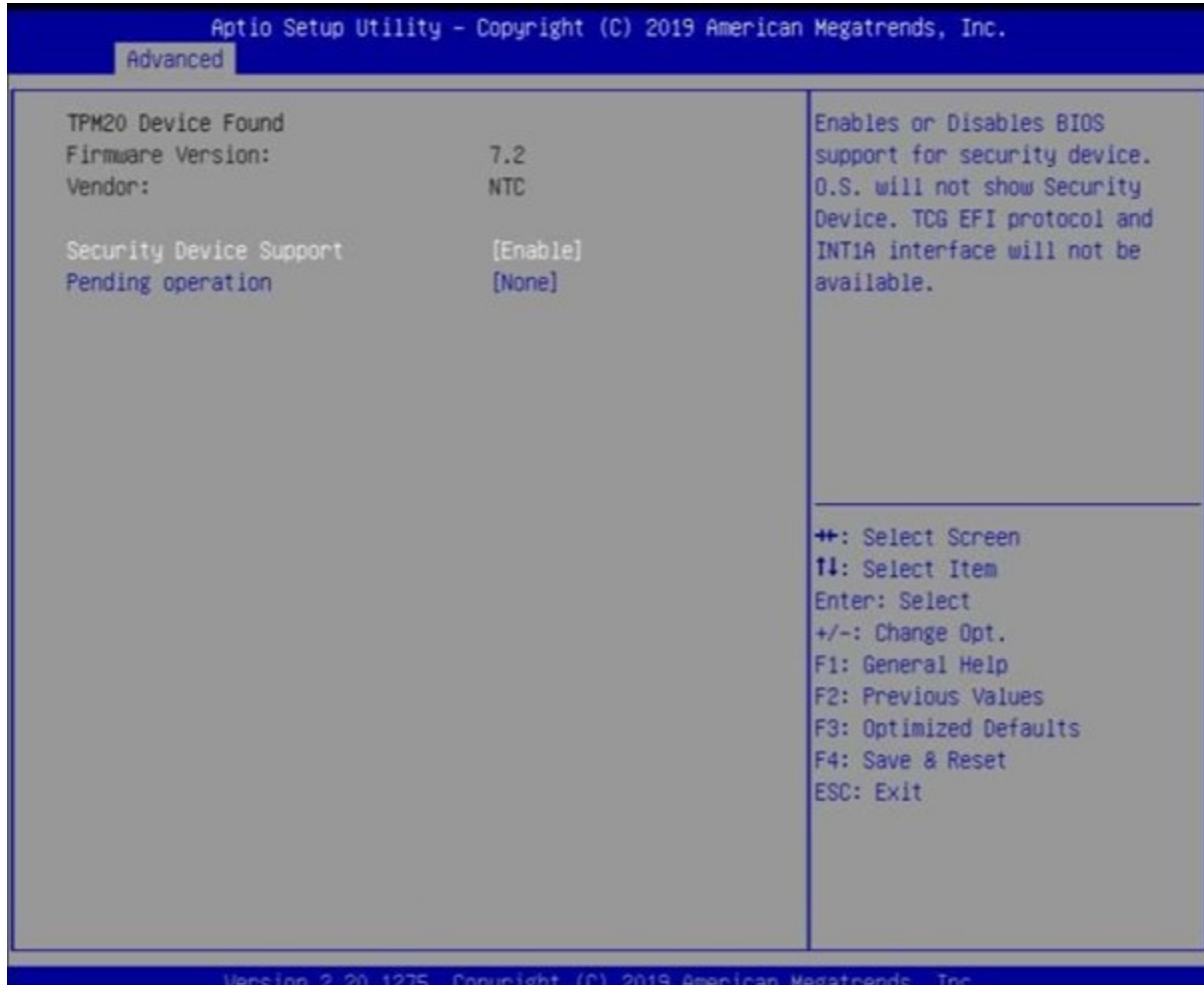

<input checked="" type="checkbox"/> Trusted Computing	Value	Trusted Computing Settings
TPM20 Device Found		
Firmware Version:	x.x	
Vendor:	xxxxxx	
Security Device Support	[Disabled] / Enabled	Enables or Disables BIOS support for security device. O.S. will not show Security Device. TCG EFI protocol and INT1A interface will not be available.
Pending operation	[None] / TPM Clear	Schedule an Operation for the Security Device. NOTE: Your Computer will reboot during restart in order to change State of Security Device.

5.2.4 WatchDog

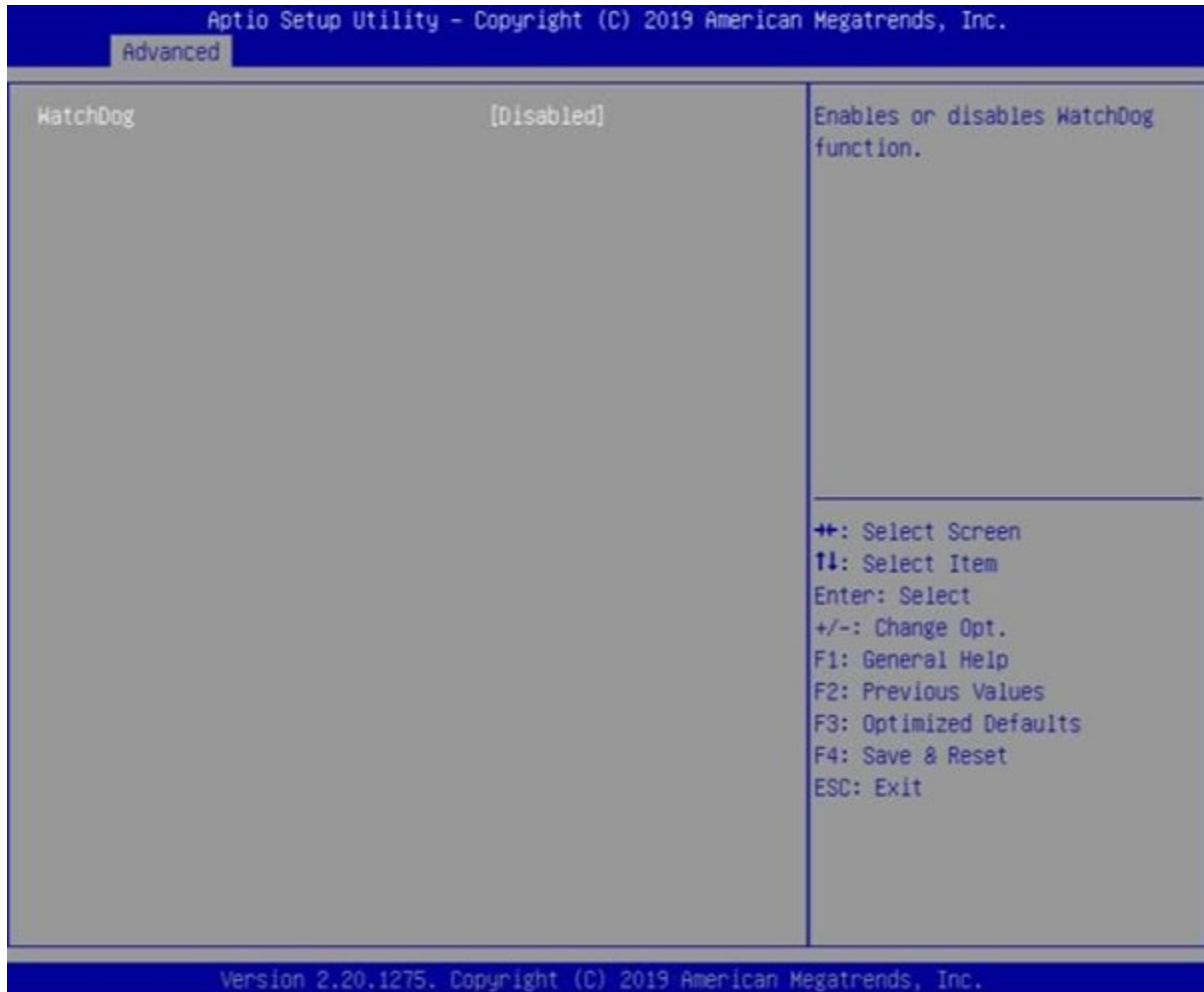

<input checked="" type="checkbox"/> WatchDog	Value	WatchDog Configuration
WatchDog	[Disabled] / Enabled	Enables or Disables WatchDog function.

<input checked="" type="checkbox"/> Super IO Configuration	Value	System Super IO Chip Parameters.
Super IO Configuration		
Super IO Chip	NCT6116D	

<input checked="" type="checkbox"/> Serial Port 1 Configuration	Value	Set Parameters of Serial Port 1 (COMA)
Serial Port 1 Configuration		
Serial Port	Disabled / [Enabled]	Enable or Disable Serial Port (COM)
Device Settings	IO=3F8h; IRQ=4	
Change settings	[Auto] / IO=3F8h; IRQ=4 / IO=3F8h; IRQ=3, 4, 5, 6, 7, 9, 10, 11, 12 / IO=2F8h; IRQ=3, 4, 5, 6, 7, 9, 10, 11, 12 / IO=3E8h; IRQ=3, 4, 5, 6, 7, 9, 10, 11, 12 / IO=2E8h; IRQ=3, 4, 5, 6, 7, 9, 10, 11, 12	Select an optimal settings for Super IO Device
Mode Configuration	[RS232] / RS485 / RS422	Configure serial port as RS232/RS422/RS485.

<input checked="" type="checkbox"/> Serial Port 2 Configuration	Value	Set Parameters of Serial Port 2 (COMB)
Serial Port 2 Configuration		
Serial Port	Disabled / [Enabled]	Enable or Disable Serial Port (COM)
Device Settings	IO=2E8h; IRQ=4	
Change settings	[Auto] / IO=2E8h; IRQ=7 / IO=3E8h; IRQ=3, 4, 5, 6, 7, 9, 10, 11, 12 / IO=2E8h; IRQ=3, 4, 5, 6, 7, 9, 10, 11, 12 / IO=2F0h; IRQ=3, 4, 5, 6, 7, 9, 10, 11, 12 / IO=2E0h; IRQ=3, 4, 5, 6, 7, 9, 10, 11, 12	Select an optimal settings for Super IO Device
Mode Configuration	[RS232] / RS485 / RS422	Configure serial port as RS232/RS422/RS485.

5.2.6 NCT6116D HW Monitor

Aptio Setup Utility - Copyright (C) 2019 American Megatrends, Inc.

Advanced

PC Health Status		If Enabled, POST monitors voltage, temperature, and fan status. If these values are out of range, BIOS display warning message and turn on beep sound.
Hardware Monitor Alert Enable	[Disabled]	
CPU Temperature	: +54 ℃	++: Select Screen ↑↓: Select Item Enter: Select +/-: Change Opt. F1: General Help F2: Previous Values F3: Optimized Defaults F4: Save & Reset ESC: Exit
CPU VR Temperature	: +32 ℃	
DIMM Temperature	: +31 ℃	
System Fan_Internal Speed	: 1831 RPM	
System Fan_External Speed	: N/A	
VCORE	: +1.136 V	
PCH IO volt	: +1.048 V	
System Memory	: +1.200 V	
AVSB	: +3.344 V	
VSB3V	: +3.296 V	

Version 2.20.1275. Copyright (C) 2019 American Megatrends, Inc.

<input type="checkbox"/> NCT6116D HW Monitor	Value	Monitor hardware status
PC Health Status		
Hardware MonitorAlert Enable	[Disabled] / Enabled	If Enabled, POST monitors voltage, temperature, and fan status. If these values are out of range, BIOS display warning message and turn on beep sound.
CPU Temperature	xx °C	
CPU VR Temperature	xx °C	
DIMM Temperature	xx °C	
System Fan_Internal Speed	xx RPM	
System Fan_External Speed	xx RPM	
VCORE	xx V	
PCH IO volt	xx V	
System Memory	xx V	
AVSB	xx V	
VSB3V	xx V	

5.2.7 S5 RTC Wake Setting



☒ S5 RTC Wake Setting	Value	Enable System to wake from S5 using RTC alarm
Wake System with Fixed Time from S5	[Disabled] / Fixed Time / Dynamic Time	Enable or disable System wake on alarm event. Select FixedTime, system will wake on the hr::min::sec specified. Select DynamicTime, System will wake on the current time + Increase minute(s)

5.2.8 Network Stack Configuration



<input checked="" type="checkbox"/> Network Stack Configuration	Value	Network Stack Settings
Network Stack	[Disabled] / Enabled	Enable/Disable UEFI Network Stack

5.2.9 NVMe Configuration

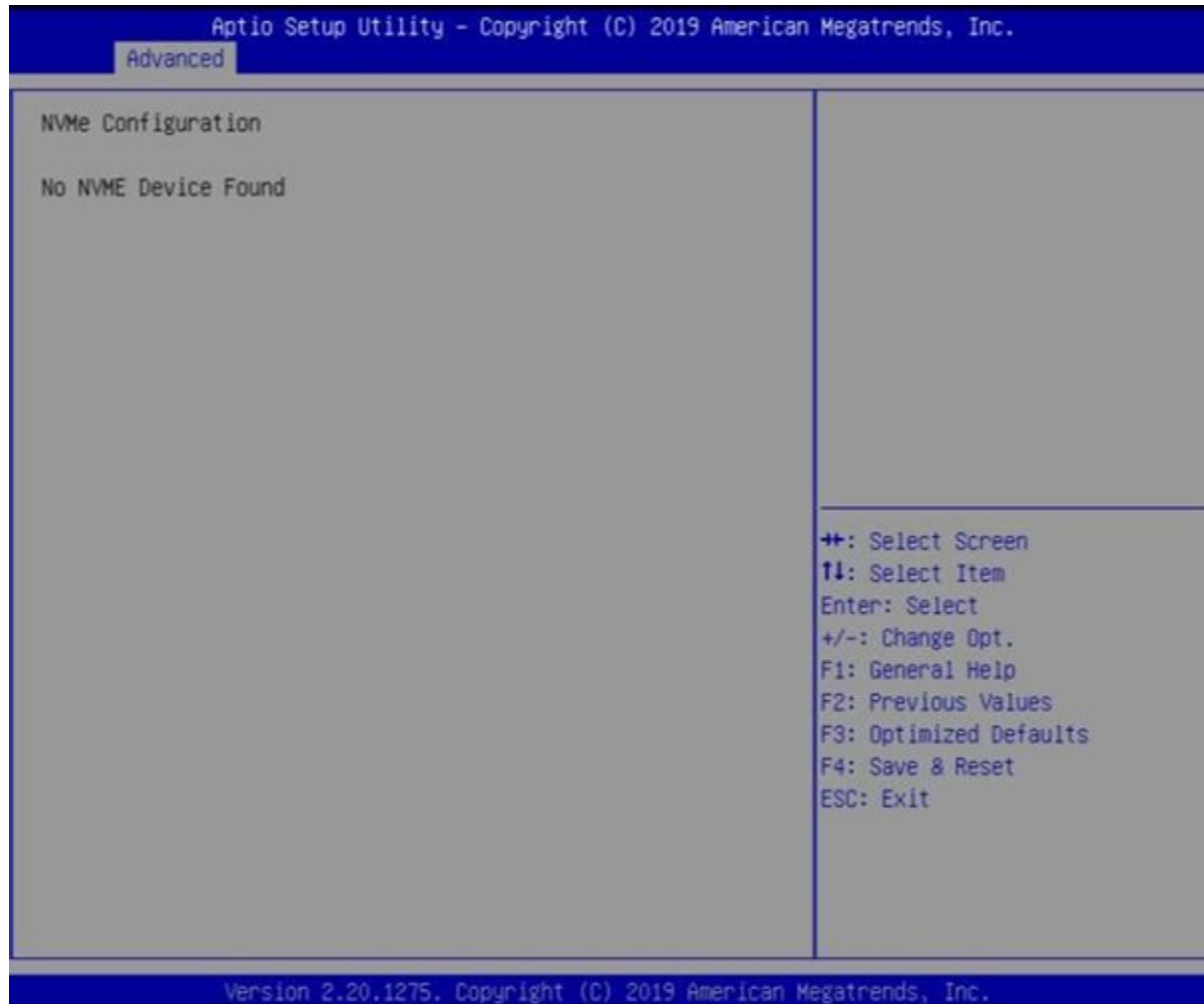

5.3 Security Page

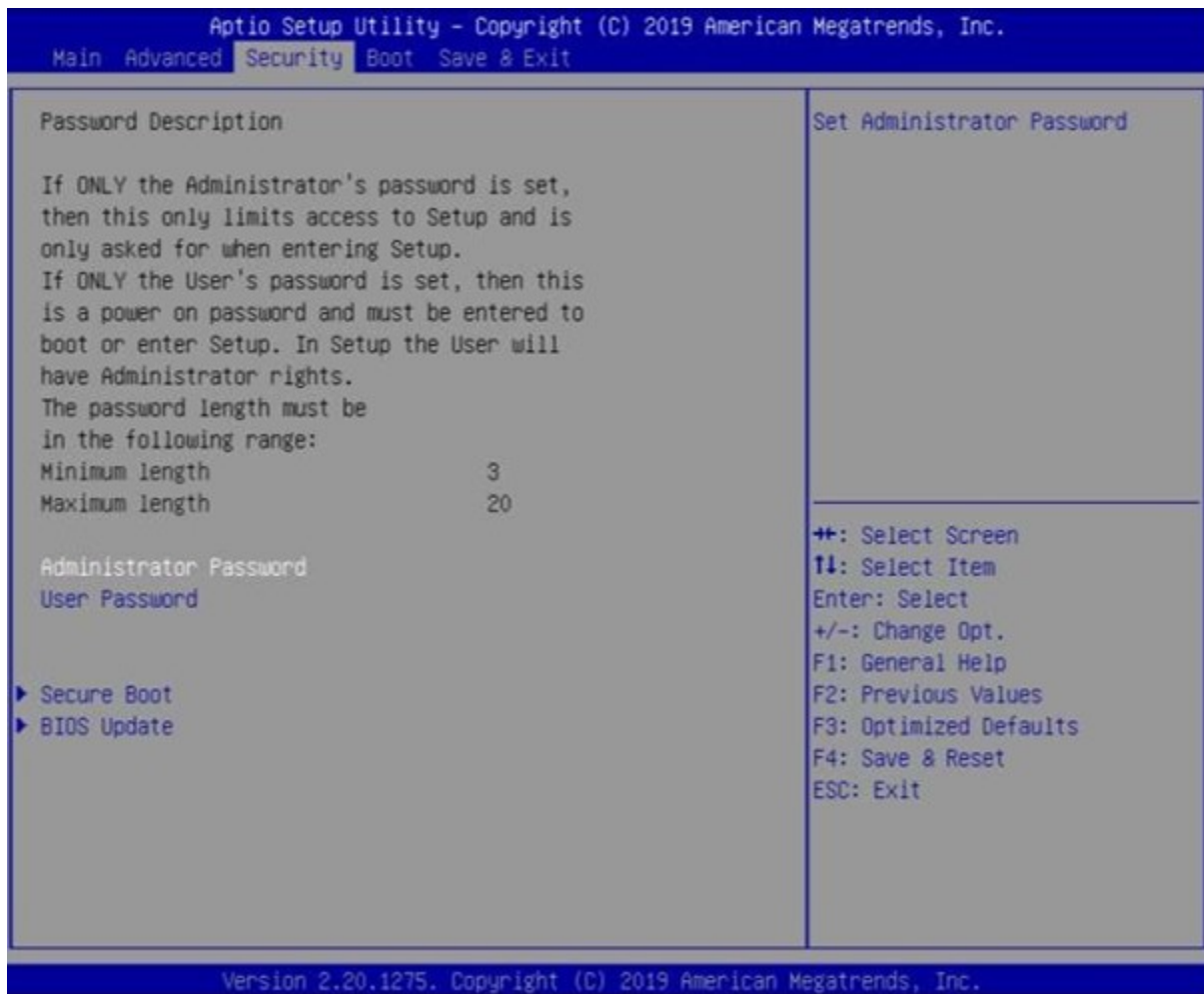

Security	Value	Description
Password Description		
Administrator Password	xxxx	Set Administrator Password
User Password	xxxx	Set User Password
<input checked="" type="checkbox"/> HDD Security drive(EX: xxxxxxxxxxxx)		HDD Security Configuration for selected drive
<input checked="" type="checkbox"/> Secure Boot		Secure Boot configuration
<input checked="" type="checkbox"/> BIOS Update		BIOS Update support

5.3.1 Secure Boot



<input checked="" type="checkbox"/> Secure Boot	Value	Secure Boot configuration
System Mode	xxxx	
Secure Boot	[Disabled] / Enabled	Secure Boot feature is Active if Secure Boot is Enable, Platform Key(PK) is enrolled and the System is in User mode. The mode change requires platform reset
Secure Boot Mode	Standard / [Customer]	Secure Boot mode options: Standard or Custom. In Custom mode, Secure Boot Policy variables can be configured by a physically present user without full authentication
<input checked="" type="checkbox"/> Restore Factory Keys	[Yes] / No	Force System to User Mode. Install factory default Secure Boot key database
<input checked="" type="checkbox"/> Reset To Setup Mode	[Yes] / No	Delete all Secure Boot key databases from NVRAM

Aptio Setup Utility - Copyright (C) 2019 American Megatrends, Inc.

Security

<p>Vendor Keys Modified</p> <p>Factory Key Provision [Disabled]</p> <ul style="list-style-type: none"> ▶ Restore Factory Keys ▶ Reset To Setup Mode ▶ Export Secure Boot variables ▶ Enroll Efi Image <p>Device Guard Ready</p> <ul style="list-style-type: none"> ▶ Remove 'UEFI CA' from DB ▶ Restore DB defaults <table border="1" style="width: 100%; border-collapse: collapse; margin-top: 10px;"> <thead> <tr> <th style="text-align: left;">Secure Boot variable</th> <th style="text-align: left;">Size</th> <th style="text-align: left;">Keys</th> <th style="text-align: left;">Key Source</th> </tr> </thead> <tbody> <tr> <td>▶ Platform Key(PK)</td> <td>835</td> <td>1</td> <td>Factory</td> </tr> <tr> <td>▶ Key Exchange Keys</td> <td>1560</td> <td>1</td> <td>Factory</td> </tr> <tr> <td>▶ Authorized Signatures</td> <td>3143</td> <td>2</td> <td>Factory</td> </tr> <tr> <td>▶ Forbidden Signatures</td> <td>3724</td> <td>77</td> <td>Factory</td> </tr> <tr> <td>▶ Authorized TimeStamps</td> <td>0</td> <td>0</td> <td>No Keys</td> </tr> <tr> <td>▶ OsRecovery Signatures</td> <td>0</td> <td>0</td> <td>No Keys</td> </tr> </tbody> </table>	Secure Boot variable	Size	Keys	Key Source	▶ Platform Key(PK)	835	1	Factory	▶ Key Exchange Keys	1560	1	Factory	▶ Authorized Signatures	3143	2	Factory	▶ Forbidden Signatures	3724	77	Factory	▶ Authorized TimeStamps	0	0	No Keys	▶ OsRecovery Signatures	0	0	No Keys	<p>Install factory default Secure Boot keys after the platform reset and while the System is in Setup mode</p> <hr/> <p> ++: Select Screen ↑↓: Select Item Enter: Select +/-: Change Opt. F1: General Help F2: Previous Values F3: Optimized Defaults F4: Save & Reset ESC: Exit </p>
Secure Boot variable	Size	Keys	Key Source																										
▶ Platform Key(PK)	835	1	Factory																										
▶ Key Exchange Keys	1560	1	Factory																										
▶ Authorized Signatures	3143	2	Factory																										
▶ Forbidden Signatures	3724	77	Factory																										
▶ Authorized TimeStamps	0	0	No Keys																										
▶ OsRecovery Signatures	0	0	No Keys																										

Version 2.20.1275. Copyright (C) 2019 American Megatrends, Inc.

☒ Key Management		Enables expert users to modify Secure Boot Policy variables without full authentication
Vendor Keys	Invalid / Valid	
Factory Key Provision	[Disabled] / Enabled	Install factory default Secure Boot keys after the platform reset and while the System is in Setup mode
☒ Restore Factory Keys	[Yes] / No	Force System to User Mode. Install factory default Secure Boot key database
☒ Reset To Setup Mode	[Yes] / No	Delete all Secure Boot key databases from NVRAM
☒ Export Secure Boot variables	Drive: \Path	Copy NVRAM content of Secure Boot variables to files in a root folder on a file system device
☒ Enroll Efi Image	xxxxxxxxxxxxxxx	Allow the image to run in Secure Boot mode. Enroll SHA256 Hash certificate of a PE image into Authorized Signature Database (db)
Device Guard ready		
☒ Remove 'UEFI CA' from DB		Device Guard ready system must not list 'Microsoft UEFI CA' Certificate in Authorized Signature database (db)
☒ Remove DB defaults	[Yes] / No	Restore DB variable to factory defaults
Secure Boot variables Size Keys Key Source		
☒ Platform Key(PK)	[Details] / Export / Update / Delete	Enroll Factory Defaults or load certificates from a file: 1.Public Key Certificate: a)EFI_SIGNATURE_LIST b)EFI_CERT_X509 (DER) c)EFI_CERT_RSA2048 (bin) d)EFI_CERT_SHAXXX 2.Authenticated UEFI Variable 3. EFI PE/COFF Image(SHA256) Key Source: Factory, External,Mixed
☒ Key Exchange Keys	[Details] / Export / Update / Append / Delete	Enroll Factory Defaults or load certificates from a file: 1.Public Key Certificate: a)EFI_SIGNATURE_LIST b)EFI_CERT_X509 (DER) c)EFI_CERT_RSA2048 (bin) d)EFI_CERT_SHAXXX 2.Authenticated UEFI Variable 3. EFI PE/COFF Image(SHA256) Key Source: Factory, External,Mixed
☒ Authorized Signatures	[Details] / Export / Update / Append / Delete	Enroll Factory Defaults or load certificates from a file: 1.Public Key Certificate: a)EFI_SIGNATURE_LIST b)EFI_CERT_X509 (DER) c)EFI_CERT_RSA2048 (bin) d)EFI_CERT_SHAXXX 2.Authenticated UEFI Variable 3. EFI PE/COFF Image(SHA256) Key Source: Factory, External,Mixed
☒ Forbidden Signatures	[Details] / Export / Update / Append / Delete	Enroll Factory Defaults or load certificates from a file: 1.Public Key Certificate: a)EFI_SIGNATURE_LIST b)EFI_CERT_X509 (DER) c)EFI_CERT_RSA2048 (bin) d)EFI_CERT_SHAXXX 2.Authenticated UEFI Variable 3. EFI PE/COFF Image(SHA256) Key Source: Factory, External,Mixed
☒ Authorized TimeStamps	[Details] / Export / Update / Append / Delete	Enroll Factory Defaults or load certificates from a file: 1.Public Key Certificate: a)EFI_SIGNATURE_LIST b)EFI_CERT_X509 (DER) c)EFI_CERT_RSA2048 (bin) d)EFI_CERT_SHAXXX 2.Authenticated UEFI Variable 3. EFI PE/COFF Image(SHA256) Key Source: Factory, External,Mixed
☒ OS Recovery Signatures	[Details] / Export / Update /	Enroll Factory Defaults or load certificates from a file: 1.Public Key Certificate: a)EFI_SIGNATURE_LIST b)EFI_CERT_X509 (DER) c)EFI_CERT_RSA2048 (bin) d)EFI_CERT_SHAXXX 2.Authenticated UEFI Variable 3. EFI PE/COFF Im-

5.3.2 BIOS Update



5.4 Boot Page

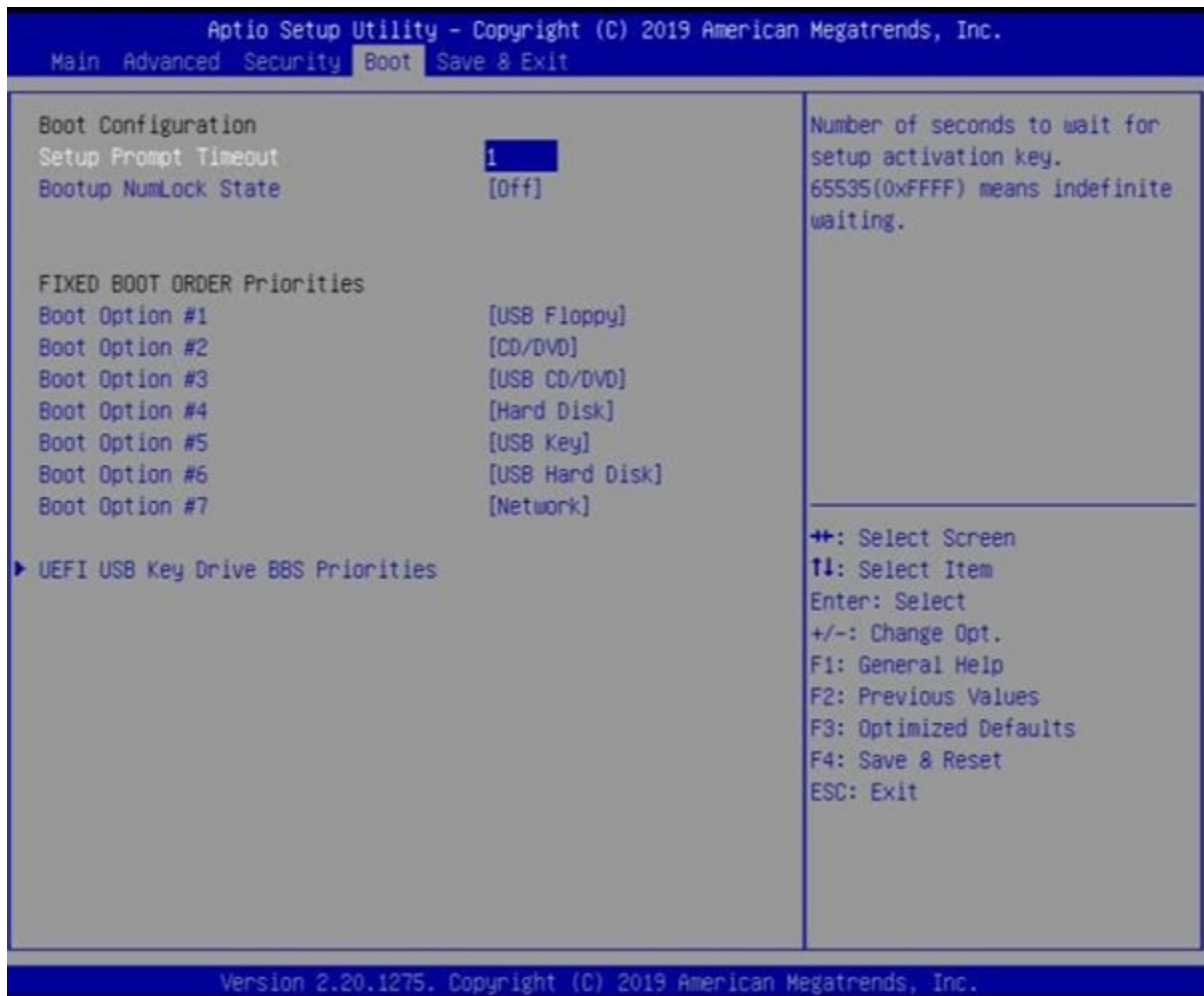

Boot	Value	Description
Setup Prompt Timeout	1	Number of seconds to wait for setup activation key. 65535(0xFFFF) means indefinite waiting.
Bootup Num-Lock State	On / [Off]	Select the keyboard NumLock state
FIXED BOOT ORDER Priorities		
Boot #1 Optoin	[USB Floppy] / CD/DVD / USB CD/DVD / Hard Disk / USB Key / USB Hard Disk / Network / Disable	Sets the system boot orfer
Boot #2 Optoin	USB Floppy / [CD/DVD] / USB CD/DVD / Hard Disk / USB Key / USB Hard Disk / Network / Disable	Sets the system boot orfer
Boot #3 Optoin	USB Floppy / CD/DVD / [USB CD/DVD] / Hard Disk / USB Key / USB Hard Disk / Network / Disable	Sets the system boot orfer
Boot #4 Optoin	USB Floppy / CD/DVD / USB CD/DVD / [Hard Disk] / USB Key / USB Hard Disk / Network / Disable	Sets the system boot orfer
Boot #5 Optoin	USB Floppy / CD/DVD / USB CD/DVD / Hard Disk / [USB Key] / USB Hard Disk / Network / Disable	Sets the system boot orfer
Boot #6 Optoin	USB Floppy / CD/DVD / USB CD/DVD / Hard Disk / USB Key / [USB Hard Disk] / Network / Disable	Sets the system boot orfer
Boot #7 Optoin	USB Floppy / CD/DVD / USB CD/DVD / Hard Disk / USB Key / USB Hard Disk / [Network] / Disable	Sets the system boot orfer

5.4.1 Save & Exit Page

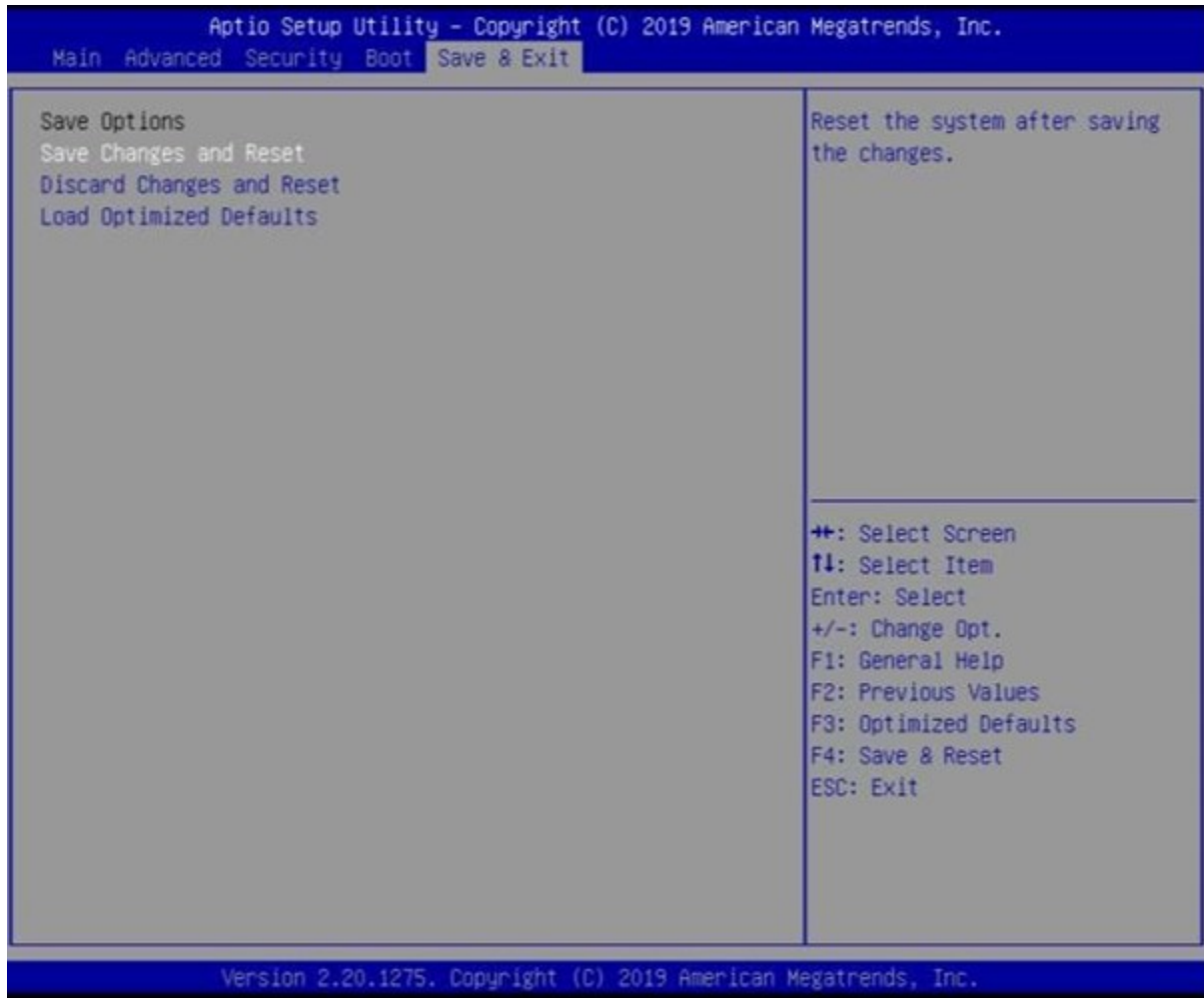

Save & Exit	Description
Save Changes and Reset	Reset the system after saving the changes.
Discard Changes and Reset	Reset system setup without saving any changes.
Load Optimized Defaults	Restore/Load Default values for all the setup options.